

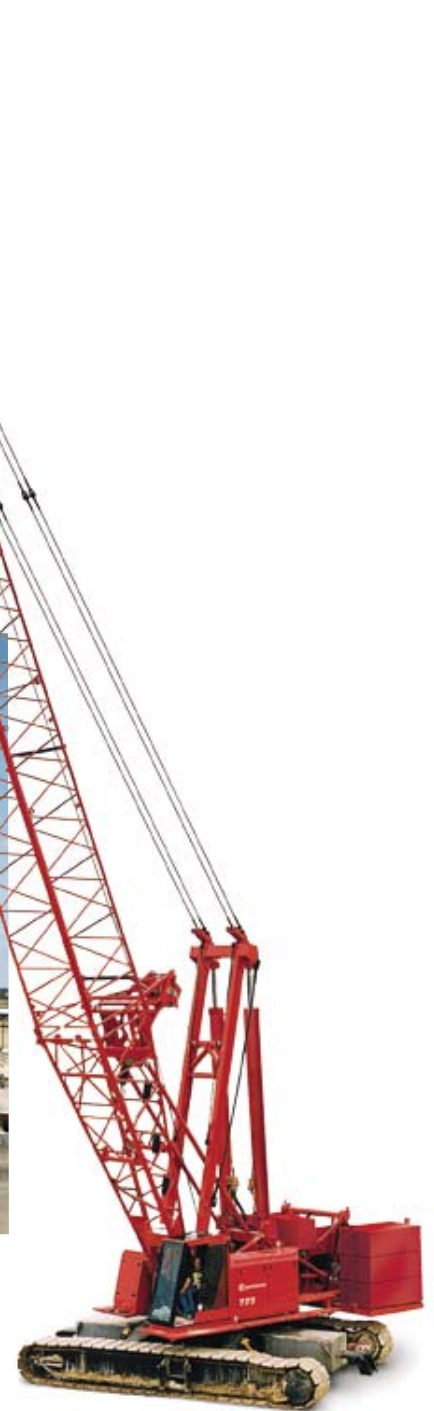

천조코퍼레이션
CHUNJO CORPORATION



Manitowoc 777 Product Guide



CHUNJO Corporation

9F Jung Woo B/D, 1111, Chunnodaero, Gangdong-gu,
Seoul, Republic of Korea 05544

Tel : 82-2-489-3438

Fax : 82-2-489-3439

www.chunjo.com

Features



EPIC®

Manitowoc's field-proven Electronically Processed Independent Controls (EPIC) system delivers high productivity and precise load control by instantly matching an operator's commands to the crane function. EPIC's microprocessor maximizes a Manitowoc crane's function capability and simplifies servicing by pinpointing any problem in the crane's engine, power transmission and other operating systems. In addition, EPIC increases versatility by easily tailoring a Manitowoc crane's operation for specialized applications, with or without attachments. EPIC is a key reason no other crane can match the performance and reliability of Manitowoc.

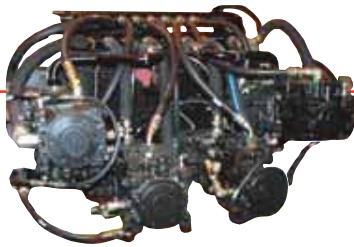

Hydraulics

Our closed-loop system provides a separate hydraulic circuit to power each crane function. The result is truly independent, variable-speed operation of the swing, load hoist, boom hoist and travel functions.



FACT™ Connectors

Manitowoc's Fast Aligning Connection Technology (FACT) quickly aligns crane components for fast, safe assembly and disassembly.



Crawler drive shafts

The crawler drive shafts prevent contaminants from entering the system. By eliminating the need to disconnect hydraulic systems, crawler removal and assembly is safer and easier.

Contents

Specifications	4
Outline dimensions	7
Transport data	13
Crane assembly	14
Performance data	15
Boom combinations	22
Heavy-lift boom range / load charts	24
Fixed jib boom range / load charts	26
Luffing jib boom range / load charts	29
Fixed jib on luffing jib boom range / load charts	33
Manitowoc Crane Care	37

Specifications

Upperworks



Engine

Cummins Model QSC8.3 – C340 diesel, 6 cylinder, 253 kW (340 BHP) @ 2100 governed RPM.

Optional Caterpillar Model C-9 diesel, 6 cylinder, 253 kW (340 BHP) @ 2100 governed RPM.

Includes engine block heater (120 V), ether starting aid, manually operated disconnect clutch for cold weather starting, high silencing muffler, hydraulic oil cooler, radiator and fan.

Multiple hydraulic pump drive transmission provides independent power for all machine functions.

Two 12 volt maintenance-free, Group 8D batteries, 1400 CCA at -18°C (0° F), 24 volt starting and 120 amp alternator.

One 469 l (124 gal) capacity diesel fuel tank, mounted on rear of upperworks, with level indicator in operator's cab.



Controls

Modulating electronic-over-hydraulic controls provide infinite speed response directly proportional to control lever movement. Controls include Manitowoc's exclusive EPIC[®] Electronically Processed Independent Control system providing microprocessor driven control logic, pump control, on-board diagnostics, and service information.

Block-up limit control is standard for hoist and auxiliary lines.

Integrated Load Moment Indicator system (LMI) is standard for main boom. "Function cut-out" or "warning only" operation is selected via a keyed switch on the LMI console. Includes travel and swing alarms.

Optional: upper boom point assembly with LMI.

Optional: anemometer (wind indicator).

Optional: foot controls for travel.



Hydraulic system

Six high-pressure piston pumps are driven through a multi-hydraulic pump transmission. These six pumps

provide independent "closed loop" hydraulic power for front drum, rear drum, boom hoist system, swing system, and both left and right crawler operation.

System	kg/cm ² (psi)	lpm (gpm)
Front Drum	422 (6,000)	300 (79)
Rear Drum	422 (6,000)	300 (79)
Boom Hoist	422 (6,000)	300 (79)
Swing System	386 (5,500)	225 (59)
Left Crawler	422 (6,000)	225 (59)
Right Crawler	422 (6,000)	225 (59)
Auxiliary Pump*	422 (6,000)	390 (102)

*Optional pump powers auxiliary drum on liftcrane.

Hydraulic reservoir capacity is 469 l (124 gal) and is equipped with breather, dipstick, clean out access, and internal diffuser.

Each function is equipped with relief valves to protect the hydraulic circuit from overload or shock.

Replaceable, spin on ten micron (absolute) full flow line filter is furnished in the hydraulic circuit. All oil is filtered prior to return to the hydraulic reservoir.

Hydraulic system also includes pump transmission disconnect clutch and hydraulic oil cooler.



Drums

Two equal width winches 770 mm (30-1/8") wide and 495 mm (19-1/2") diameter are driven by independent variable displacement axial piston hydraulic motors through planetary reduction mounted on separate front and rear shafts with anti-friction bearings.

Powered hoisting/lowering operation is standard with automatic (spring applied, hydraulically released) multi-disc brakes, and drum rotation indicators.

Optional: free-fall operation for front and/or rear drum(s). External contracting band brake mounted on drum manually applied by foot pedal with locking latch in operator's cab. Operator may select free-fall or powered lowering mode using a selector switch.

Optional: high line speed drum 205m/min (674 fpm) can be ordered in place of standard front or rear drum.

Optional: high line pull drum 195 kN (44,000 lb) can be ordered in place of standard front or rear drum.

Optional: auxiliary (third) hydraulic powered drum rated at 89,0 kN (20,000 lb) line pull mounted in boom butt. Includes third drum control system.

Specifications

- ▶ Optional: auxiliary drum preparation includes electric wiring, controls, hydraulic pump and plumbing.
- ▶ Optional: bolt-on liftcrane/clamshell laggings.
- ▶ Optional: wire rope for various applications.



Mast

Moving mast is 7,9 m (26') long and connects the boom hoist cylinders to the boom-support pendants.

Spring cushioned boom stop and automatic boom stop standard.



Boom hoist

Independent boom hoist is provided by two double-acting hydraulic cylinders connected to the mast. Boom hoist provides full range of boom angles from horizontal to 88 degrees, with or without load.

Boom hoist speed: raise 82,3 m (270') full main boom from 0° - 82° in 1 minute, 40 seconds.

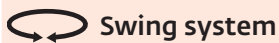

Swing system

High strength fabricated steel rotating bed is mounted on 2,15 m (84-1/2") diameter turntable single-row ball bearing.

Independent swing powered by a fixed displacement hydraulic motor coupled to a planetary gearbox with internal brake. 360° positive swing lock.

Swing system maximum speed: 2.7 rpm.

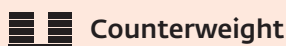

Counterweight

Includes connecting pins, brackets, and stops.

Qty.	Item	Unit Weight		Total Weight	
		kg	lb	kg	lb
Series 1					
1	Tray	15 876	35,000	15 876	35,000
4	Upper side box	7 938	17,500	31 752	70,000
Series 1 Total				47 628	105,000
Series 2					
2	Upper Side Box	7 938	17,500	15 876	35,000
2	Upper Side Plate	454	1,000	908	2,000
2	Carbody Box	9 979	22,000	19 958	44,000
Series 2 Sub-Total				36 742	81,000
▶ Optional: add to Series 1 for Series 2 Total				84 370	186,000



Operator's cab

Fully enclosed and insulated steel module located at the left front corner of rotating bed. Module is equipped with sliding door, large safety glass windows on all sides and roof. Signal horn, cab space heater, front and roof windshield wipers, dome light, sun visor and shade, fire extinguisher and air circulating fan are standard.

- ▶ Optional air conditioner.
- ▶ Optional nylon protective window covers.

Lowerworks



Carbody

Connects rotating bed to crawler assemblies. High strength fabricated steel assembly with FACT™ connection system for fast installation and removal of crawler assemblies.



Crawlers

Crawler assemblies are 7,55 m (24' 9-1/4") long with 97 cm (38") wide cast steel crawler pads and sealed "low maintenance" intermediate rollers. Each crawler is powered independently by a variable displacement hydraulic motor and includes two hydraulically powered pin actuators for fast installation and removal from carbody. Carbody mounted drive motors are connected to crawler final reduction via telescoping shafts. This permits crawlers to be removed without opening their hydraulic circuits. Crawlers provide ample tractive effort that allows counter rotation with full rated load. Maximum ground speed of 1,7 kph (1.05 mph).

▶ Optional: self-erect system includes: carbody jacking cylinders with pads, controls, 41 t (45 USt) assembly block, boom-butt installation support, and crawler handling chains.

▶ Optional: 122 cm (48") wide-cast steel crawler pads.

Attachments



No. 78 heavy-lift main boom

The liftcrane is equipped with a 18,3 m (60') No. 78 basic heavy-lift angle chord boom consisting of a 6,9 m (22' 6") butt and 11,4 m (37' 6") top with six 76,2 cm

Specifications

(30") diameter roller bearing sheaves on one shaft. Includes rope guides, and boom angle indicator. The No. 78 boom utilizes pendant rigging and Manitowoc's exclusive FACT™ connection system. The FACT connection system consists of two vertical pins, two horizontal connection pins and alignment pads for each boom connection location.

Luffing jib preparation included as standard.

- Optional: 3,05 m (10'), 6,1 m (20'), and 12,2 m (40') No. 78 boom inserts with pendant rigging and FACT™ connection system.
- Optional: No. 78 detachable upper boom point with one 76,2 cm (30") diameter tapered roller bearing steel sheave grooved for 1-1/8" rope with rope guard for liftcrane.



No. 134 fixed jib

- Optional: No. 134 basic fixed jib 9,1 m (30') length consisting of 4,6 m (15') jib butt and 4,6 m (15') jib top with 3,7 m (12') jib strut, pendants and backstay. Includes LMI hardware.
- Optional: No. 134 fixed jib inserts 3,05 m (10') and 6,1 m (20') with pendants.

Utilize fixed jib inserts in combination with the No. 134 basic fixed jib for total lengths up to 24,4 m (80').

Note: Jib lengths greater than 18,3 m (60') require the use of at least one 6,1 m (20') No. 134 fixed jib insert.



No. 138 fixed jib

- Optional: No. 138 basic fixed jib 9,1 m (30') length consisting of 4,6 m (15') jib butt and 4,6 m (15') jib top with 5,4 m (17' 9-7/16") jib strut, pendants and backstay. For use with No. 139 Luffing Jib.
- Optional: No. 138 fixed jib inserts 3,0 m (10') and 6,1 m (20') with pendants.

Utilize fixed jib inserts in combination with the No. 138 basic fixed jib for total lengths up to 18,3 m (60').

Optional equipment

- Optional: Blocks and Hooks, each with 762 mm (30") roller-bearing sheaves for 26 mm or (1")

wire rope, a roller-bearing swivel hook, a hook latch, and a swivel lock.

13,6 t (15 USt) swivel hook and weight ball.

41,0 t (45 USt) hook block with one 76,2 cm (30") sheave (assembly block)

54,4 t (60 USt) hook block with two 76,2 cm (30") sheaves

90,7 t (100 USt) hook block with three 76,2 cm (30") sheaves

160 t (175 USt) hook block with six 76,2 cm (30") sheaves

- Optional: Wire rope for various applications.
- Optional: Equipment and testing for special code compliance.
- Optional: Hydraulic Test Kit: required to properly analyze the performance of the EPIC® control system.
- Optional: Service Interval Kits: for the regularly scheduled maintenance of general crane operations.
- Optional: Lighting Packages: consult dealer for available options.
- Optional: Special paint colors other than Manitowoc standard red and black.
- Optional: Custom vinyl decals of customer name and/or logo from artwork supplied by customer.
- Optional: Export Packaging: basic crane, boom and jib sections.

Optional applications

- Optional: For limited clamshell work: guide bars for lower boom point; Rud-O-Matic® No. 1866 spring-powered three-barrel tagline with 76,2 cm (36") diameter wheel; and pressure rollers for the front and rear hoisting drums. Front drum is closing line. Rear drum is holding line. Manitowoc's EPIC® controls can be changed from liftcrane to clamshell mode with the flip of a switch.

Outline dimensions

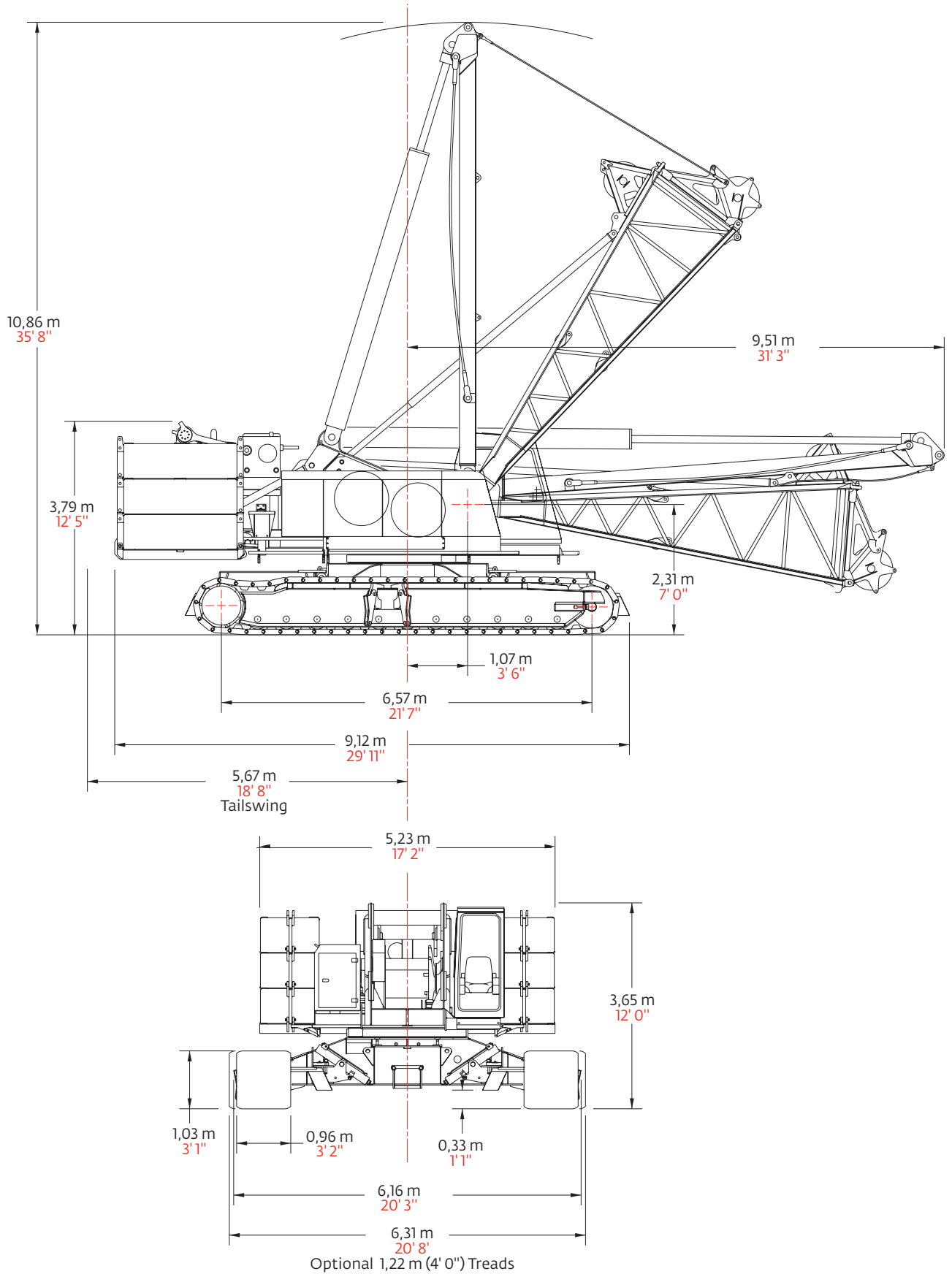

Outline dimensions

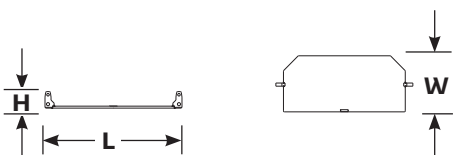
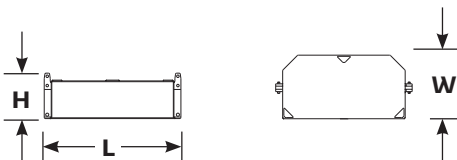
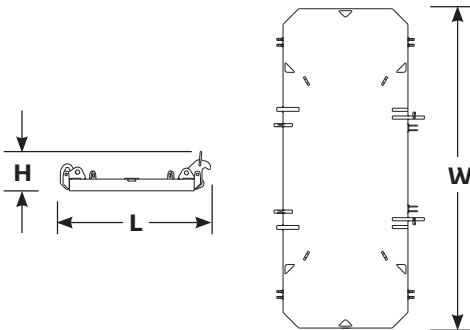
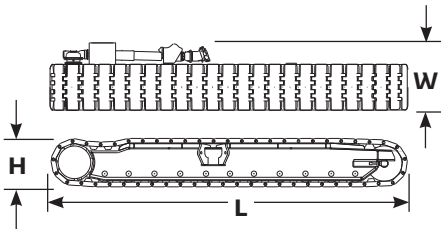
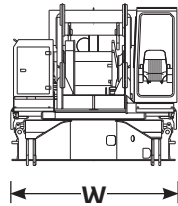
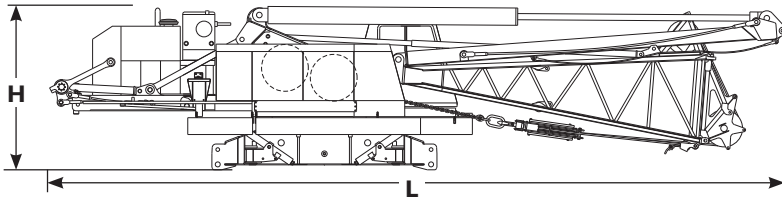

Basic crane		x 1
Length	15,17 m	49' 9"
Width	3,42 m	11' 1"
Height	3,36 m	11' 0"
Weight	39 065 kg	86,125 lb

NOTE: Weight includes carbody, upperworks, two full power drums with maximum length hoist and whip lines, diesel powerplant, operator's cab, boom hoist cylinders, mast, boom butt with integral wire rope guide, optional self-assembly jacks, full hydraulic fluid reservoir and half tank of fuel.

If equipped with butt MTD 3rd drum, add 1 967 kg / 4,340 lb.

If equipped with rope for butt MTD 3rd drum, add 818 kg / 1,805 lb.

Crawlers		x 2
Length	7,56 m	24' 10"
Width	1,47 m	4' 10"
Height	1,04 m	3' 5"
Weight	15 320 kg	33,775 lb

NOTE: 970 mm (38") wide pad, 12 795 kg (28,210 lb) weight crawlers available.

Counterweight tray		x 4
Length	2,44 m	8' 0"
Width	6,99 m	17' 1"
Height	0,64 m	2' 1"
Weight	15 876 kg	35,000 lb

Side counterweight		
Series 1		x 4
Series 2		x 6
Length	2,24 m	7' 4"
Width	1,07 m	3' 6"
Height	0,69 m	2' 3"
Weight	7 938 kg	17,500 lb

Side counterweight plate		
Series 2		x 2
Length	2,24 m	7' 4"
Width	0,90 m	3' 0"
Height	0,28 m	0' 11"
Weight	454 kg	1,000 lb

Option

Outline dimensions

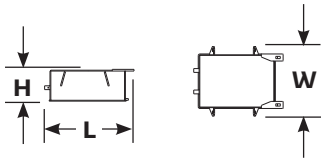

Carbody center Series 2		x 2
Length	1,90 m	6' 3"
Width	1,57 m	5' 2"
Height	0,72 m	2' 4"
Weight	9 979 kg	22,000 lb

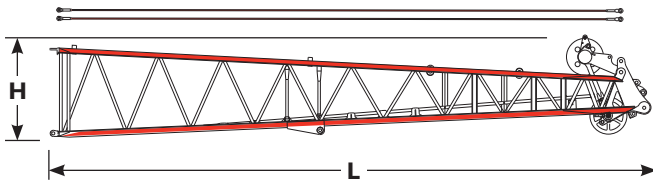

No. 78 boom top 11,4 m (37' 6") and wire rope guide, pendants, lower point		x 1
Length	12,38 m	40' 8"
Width	2,24 m	7' 4"
Height	2,04 m	6' 11"
Weight	3 567 kg	7,865 lb

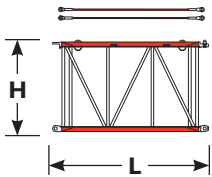

No. 78 boom insert 3,0 m (10') and pendants		x 1
Length	3,20 m	10' 6"
Width	2,24 m	7' 4"
Height	1,89 m	6' 3"
Weight	722 kg	1,595 lb

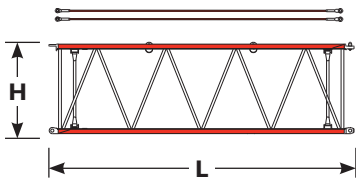

No. 78 boom insert 6,1 m (20') and pendants		x 1, 2
Length	6,25 m	20' 6"
Width	2,24 m	7' 4"
Height	1,89 m	6' 3"
Weight	1 129 kg	2,495 lb

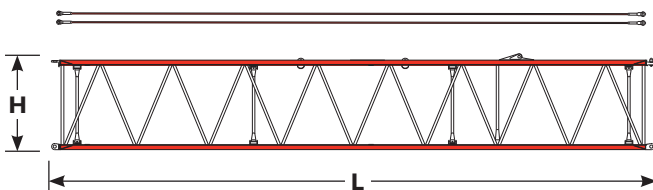

No. 78 boom insert 12,3 m (40') and pendants		x 1, 2, 3, 4
Length	12,34 m	40' 6"
Width	2,24 m	7' 4"
Height	1,89 m	6' 3"
Weight	1 994 kg	4,290 lb

Option

Outline dimensions

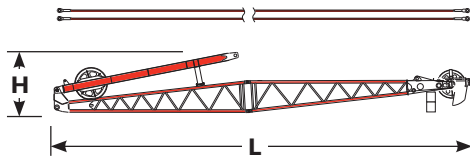

No. 134 fixed jib 9,1 m (30') and strut, pendants			x 12
Length	9,60 m	31' 6"	
Width	0,86 m	2' 10"	
Height	1,29 m	4' 3"	
Weight	1188 kg	2,620 lb	

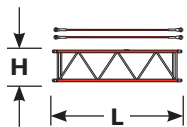

No. 134 jib insert 3,0 m (10') and pendants			x 1, 2, 3
Length	3,12 m	10' 3"	
Width	0,78 m	2' 7"	
Height	0,78 m	2' 7"	
Weight	213 kg	480 lb	

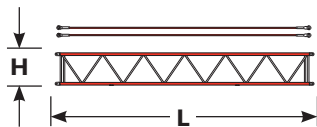

No. 134 jib insert 6,1 m (20') and pendants			x 1, 2
Length	6,16 m	20' 3"	
Width	0,78 m	2' 7"	
Height	0,78 m	2' 7"	
Weight	339 kg	750 lb	

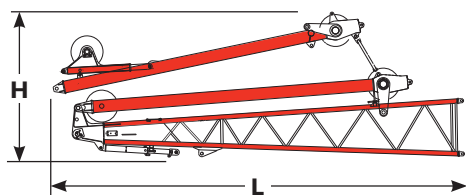

No. 139 luffing jib 8,3 m (27') butt and main strut, jib strut, guides, pendants			x 1
Length	8,78 m	28' 10"	
Width	1,51 m	5' 0"	
Height	3,14 m	10' 3"	
Weight	5 056 kg	10,460 lb	

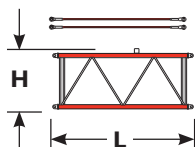

No. 139 jib insert 3,0 m (10') and pendants			x 1
Length	3,15 m	10' 4"	
Width	1,51 m	5' 0"	
Height	1,34 m	4' 5"	
Weight	379 kg	840 lb	

Option

Outline dimensions

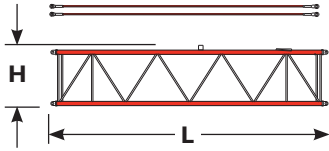

No. 139 jib insert 6,1 m (20') and pendants		x 1, 2
Length	6,20 m	20' 4"
Width	1,51 m	5' 0"
Height	1,34 m	4' 5"
Weight	610 kg	1,350 lb

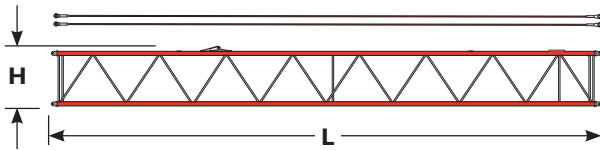

No. 139 jib insert 12,2 m (40') and pendants		x 1, 2, 3
Length	12,40 m	40' 4"
Width	1,51 m	5' 0"
Height	1,34 m	4' 5"
Weight	1 048 kg	2,315 lb

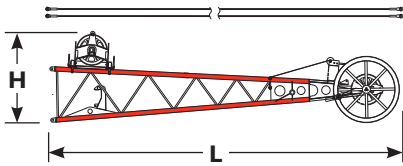

No. 139 jib top 7,0 m (23') and pendants		x 1
Length	7,83 m	25' 8"
Width	1,51 m	5' 0"
Height	2,06 m	6' 9"
Weight	2 226 kg	4,915 lb

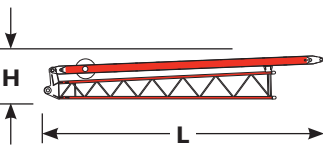

No. 139 jib insert 6,1 m (20') and pendants		x 1
Length	5,64 m	18' 6"
Width	0,75 m	2' 6"
Height	0,91 m	3' 0"
Weight	350 kg	775 lb

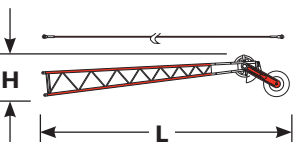

No. 138 fixed jib 4,6 m (15') top and roller, pendant		x 1
Length	5,51 m	18' 1"
Width	0,76 m	2' 6"
Height	1,05 m	3' 5"
Weight	351 kg	773 lb

Option

Outline dimensions

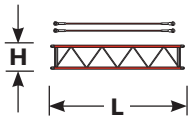

No. 138 jib insert 3,0 m (10') and pendants			x 1, 2, 3	
Length	3,12 m	10' 3"		
Width	0,76 m	2' 6"		
Height	0,58 m	1' 11"		
Weight	98 kg	215 lb		

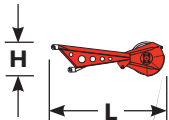

No. 78 upper boom point			x 1	
Length	2,64 m	8' 8"		
Width	0,41 m	1' 4"		
Height	0,81 m	2' 8"		
Weight	420 kg	925 lb		

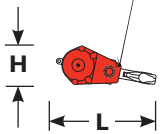

Hook block for 26 mm or (1") wire rope				
Capacity	160 t	175 USt	Length	1,68 m 8' 8"
Weight	2 268 kg	5,000 lb	Height	1,29 m 4' 0"

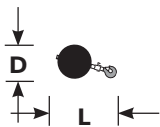

Weight ball				
Capacity/swivel	160 t	175 USt	Diameter	0,56 m 1' 10"
Weight	594 kg	1,310 lb	Length	1,07 m 3' 6"

Option

Transport data

Trailer load out summary

Item	Model 777 Series 2 No. 78 boom 82,3 m (270') and No. 134 fixed jib 24,4 m (80')								
	Weight each item	Quantity on trailer load #							
	Kg (lb)	1	2	3	4	5	6	7	8
Upperworks, carbody with No. 78 boom butt	39 065 (86,125)	1							
Crawler assembly	15 320 (33,775)		1	1					
Counterweight tray	15 876 (35,000)				1				
Upper side counterweight	7 938 (17,500)					2	2	1	1
Upper side counterweight plate	454 (1,000)							1	1
Carbody counterweight	9 979 (22,000)							1	1
No. 78 mast top, pendants	3 567 (7,865)				1				
3,0 m (10') No. 78 mast insert and pendants	722 (1,595)								1
6,1 m (20') No. 78 mast insert and pendants	1 129 (2,495)							2	
12,2 m (40') No. 78 mast insert and pendants	1 944 (4,290)		1	1		1	1		
9,1 m (30') No. 134 jib and pendants	1 586 (3,515)								1
3,0 m (10') No. 134 jib insert and pendants	216 (480)						1		
6,1 m (20') No. 134 jib insert and pendants	339 (750)					1	1		
160 t (175 USt) hook block	2 268 (5,000)		1						
Miscellaneous*									
Approximate total shipping weight each trailer load kg (lb)		39 065 (86,125)	19 534 (43,065)	17 264 (38,065)	19 443 (42,865)	18 159 (40,040)	18 375 (40,520)	20 629 (45,490)	20 679 (45,610)

Trailer configurations - double drop (#2); step deck (#'s 4-6); flat bed (#'s 7, 8).

* Miscellaneous weights vary and are not itemized for individual trailer load totals.

Crane assembly

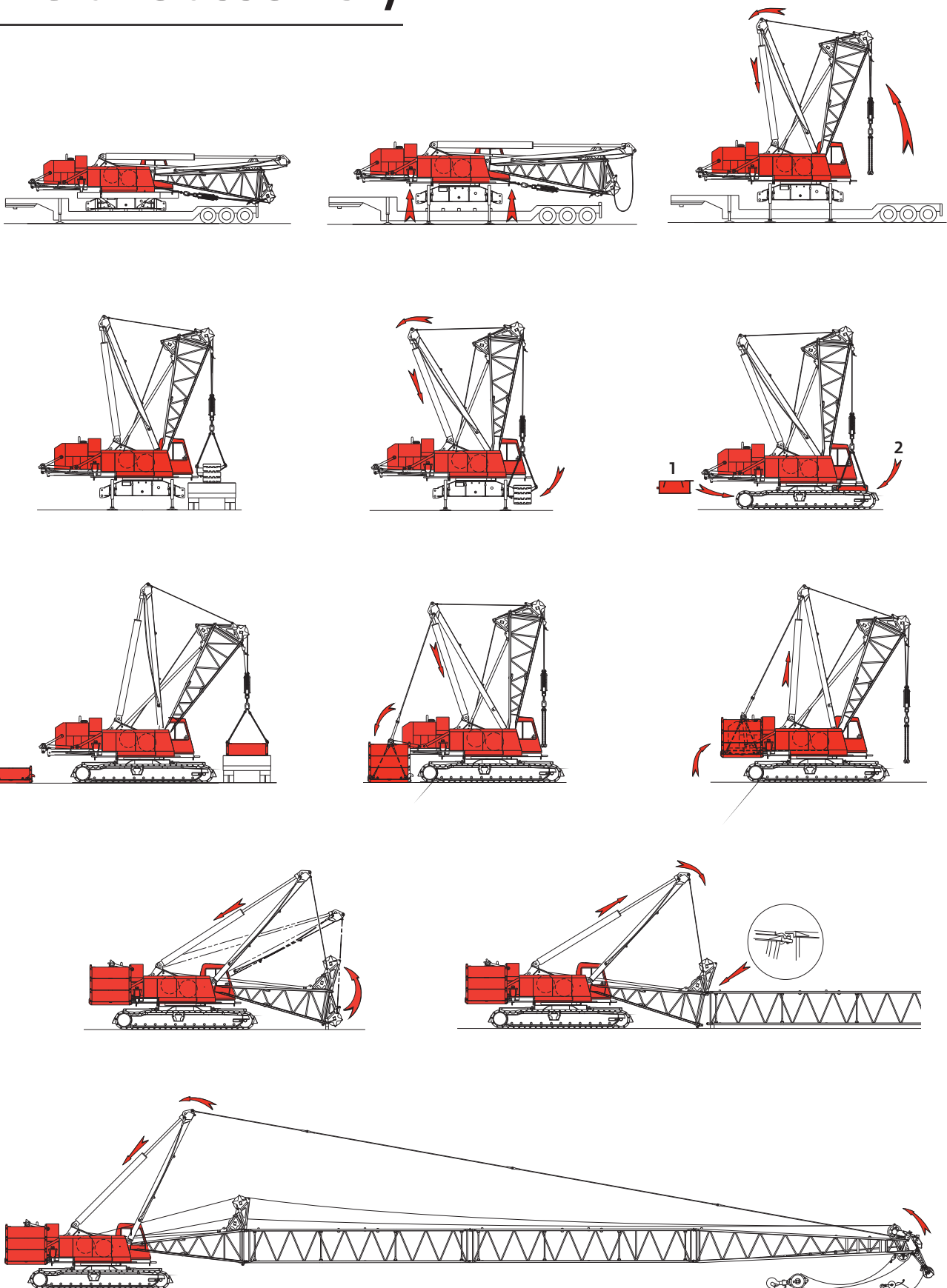

Note: Read the assembly folio in the operator's manual for a complete description of approved crane assembly procedures.

Performance data

Wire rope lengths
Boom No. 78
 - or -
Fixed jib No. 134 on boom No. 78

Boom or boom and jib length m (ft)	Whip line front, rear or auxiliary drum				Front or rear drum			Front drum			Auxiliary drum		
	(1 Part of line)		(2 Parts of line)		26 mm or (1") hoist line		Maximum required parts of line	32 mm or (1-1/4") hoist line		Maximum required parts of line	26 mm or (1") hoist line		Maximum required parts of line
	m	(ft)	m	(ft)	m	(ft)		m	(ft)		m	(ft)	
18,3 (60)	49	(160)	70	(230)	267	(875)	12	191	(625)	8	-	-	-
21,3 (70)	55	(180)	79	(260)	282	(925)	11	213	(700)	8	305	(1,000)	12
24,4 (80)	61	(200)	88	(290)	297	(975)	10	221	(725)	7	351	(1,150)	12
27,4 (90)	67	(220)	98	(320)	297	(975)	9	221	(725)	6	389	(1,275)	12
30,5 (100)	73	(240)	107	(350)	297	(975)	8	236	(775)	6	427	(1,400)	12
33,5 (110)	79	(260)	116	(380)	328	(1,075)	8	236	(775)	5	427	(1,400)	11
36,6 (120)	85	(280)	125	(410)	328	(1,075)	7	236	(775)	5	427	(1,400)	10
39,6 (130)	91	(300)	134	(440)	328	(1,075)	6	259	(850)	5	427	(1,400)	9
42,7 (140)	98	(320)	143	(470)	328	(1,075)	6	259	(850)	4	427	(1,400)	8
45,7 (150)	104	(340)	152	(500)	343	(1,125)	6	259	(850)	4	434	(1,425)	8
48,8 (160)	110	(360)	162	(530)	343	(1,125)	5	259	(850)	4	434	(1,425)	7
51,8 (170)	116	(380)	171	(560)	343	(1,125)	5	274	(900)	4	434	(1,425)	7
54,9 (180)	122	(400)	180	(590)	351	(1,150)	5	274	(900)	3	457	(1,500)	7
57,9 (190)	128	(420)	189	(620)	351	(1,150)	4	274	(900)	3	457	(1,500)	6
61,0 (200)	134	(440)	198	(650)	351	(1,150)	4	274	(900)	3	457	(1,500)	6
64,0 (210)	140	(460)	207	(680)	351	(1,150)	4	274	(900)	3	465	(1,525)	6
67,1 (220)	146	(480)	216	(710)	351	(1,150)	4	282	(975)	3	488	(1,600)	6
70,1 (230)	152	(500)	226	(740)	366	(1,200)	3	297	(1,000)	3	488	(1,600)	5
73,2 (240)	158	(520)	235	(770)	366	(1,200)	3	305	(1,000)	3	488	(1,600)	5
76,2 (250)	165	(540)	244	(800)	366	(1,200)	3	305	(1,000)	2	488	(1,600)	5
79,2 (260)	171	(560)	253	(830)	366	(1,200)	3	305	(1,000)	2	488	(1,600)	4
82,3 (270)	177	(580)	262	(860)	366	(1,200)	3	305	(1,000)	2	488	(1,600)	4
85,3 (280)	183	(600)	271	(890)									
88,4 (290)	189	(620)											
91,4 (300)	195	(640)											

NOTE: Line lengths are based on single part lead line. Hoist line and whip line lengths given in table will allow hook to touch ground. When block travel below ground is required, add additional rope equal to parts of line times added travel distance. Hoisting distance or line pull may be limited when block travel below ground is required.

Auxiliary Drum cannot be used with 18,3 m (60') boom length.

Maximum block travel with maximum parts of line may be restricted when hoist line length exceeds 213 m (700') using 32 mm (1-1/4") wire rope.

Maximum capacity with 2 part whip line using the 32 mm or (1-1/4") wire rope is 26 760 kg (59,000 lb).

Capacity chart restrictions will occur when auxiliary drum is used. Maximum capacity is 108 860 kg (240,000 lb) with 12 parts line.

Performance data

Wire rope lengths Luffing jib No. 139 on boom No. 78

Boom and luffing jib length	Luffing jib hoist line front drum							
	(4 parts of line)		(3 parts of line)		(2 parts of line)		(1 part of line)	
	m	(ft)	m	(ft)	m	(ft)	m	(ft)
42,7 (140)	229	(750)					95	(310)
45,7 (150)	244	(800)					101	(330)
48,8 (160)	259	(850)	213	(700)			107	(350)
51,8 (170)	274	(900)	221	(725)			113	(370)
54,9 (180)	290	(950)	236	(775)			119	(390)
57,9 (190)	305	(1,000)	244	(800)			125	(410)
61,0 (200)	320	(1,050)	259	(850)	198	(650)	131	(430)
64,0 (210)	335	(1,100)	274	(900)	206	(675)	137	(450)
67,1 (220)	–	–	282	(925)	213	(700)	143	(470)
70,1 (230)	–	–	297	(975)	229	(750)	149	(490)
73,2 (240)	–	–	305	(1,000)	236	(775)	155	(510)
76,2 (250)	–	–	320	(1,050)	244	(800)	162	(530)
79,2 (260)	–	–	335	(1,100)	251	(825)	168	(550)
82,3 (270)	–	–	343	(1,125)	259	(850)	174	(570)
85,3 (280)	–	–	–	–	267	(875)	180	(590)
88,4 (290)	–	–	–	–	282	(925)	186	(610)
91,4 (300)	–	–	–	–	290	(950)	192	(630)
94,5 (310)	–	–	–	–	297	(975)	198	(650)
97,5 (320)	–	–	–	–	305	(1,000)	204	(670)
100,6 (330)	–	–	–	–	312	(1,025)	210	(690)
103,6 (340)	–	–	–	–	320	(1,050)	216	(710)
106,7 (350)	–	–	–	–	–	–	223	(730)

NOTE: Line lengths are based on single part lead line. Hoist line and whip line lengths given in table will allow hook to touch ground. When block travel below ground is required, add additional rope equal to parts of line times added travel distance. Hoisting distance or line pull may be limited when block travel below ground is required.

Capacity chart restrictions will occur when auxiliary drum is used. Maximum capacity is 36 290 kg (80,000 lb) with four parts of line.

Performance data

Wire rope lengths Luffing jib No. 139 on boom No. 78

Boom and luffing jib length	Luffing jib hoist line Auxiliary drum							
	(4 parts of line)		(3 parts of line)		(2 parts of line)		(1 part of line)	
	m	(ft)	m	(ft)	m	(ft)	m	(ft)
42,7 (140)	229	(750)					95	(310)
45,7 (150)	244	(800)					101	(330)
48,8 (160)	259	(850)					107	(350)
51,8 (170)	274	(900)					113	(370)
54,9 (180)	290	(950)					119	(390)
57,9 (190)	305	(1,000)					125	(410)
61,0 (200)	320	(1,050)	259	(850)			131	(430)
64,0 (210)	335	(1,100)	274	(900)			137	(450)
67,1 (220)	351	(1,150)	282	(925)			143	(470)
70,1 (230)	366	(1,200)	297	(975)	229	(750)	149	(490)
73,2 (240)	381	(1,250)	305	(1,000)	236	(775)	155	(510)
76,2 (250)	396	(1,300)	320	(1,050)	244	(800)	162	(530)
79,2 (260)	411	(1,350)	335	(1,100)	251	(825)	168	(550)
82,3 (270)	427	(1,400)	343	(1,125)	259	(850)	174	(570)
85,3 (280)	–	–	358	(1,175)	267	(875)	180	(590)
88,4 (290)	–	–	366	(1,200)	282	(925)	186	(610)
91,4 (300)	–	–	373	(1,225)	290	(950)	192	(630)
94,5 (310)	–	–	–	–	297	(975)	198	(650)
97,5 (320)	–	–	–	–	305	(1,000)	204	(670)
100,6 (330)	–	–	–	–	312	(1,025)	210	(690)
103,6 (340)	–	–	–	–	320	(1,050)	216	(710)

NOTE: Line lengths are based on single part lead line. Hoist line and whip line lengths given in table will allow hook to touch ground. When block travel below ground is required, add additional rope equal to parts of line times added travel distance. Hoisting distance or line pull may be limited when block travel below ground is required.

Drums each provide 88,9 kN (20,000 lb) maximum single line pull.

Wire rope lengths Fixed jib No. 138 on Luffing jib No. 139 on Boom No. 80

Boom, luffing jib and fixed jib length	Fixed jib whip line Front drum or auxiliary drum	
	(1 part of line)	
	m	(ft)
94,5 (310)	198	(650)
97,5 (320)	204	(670)
100,6 (330)	210	(690)
103,6 (340)	216	(710)
106,7 (350)	223	(730)
109,7 (360)	229	(750)
112,8 (370)	235	(770)
115,8 (380)	241	(790)
118,9 (390)	247	(810)
121,9 (400)	253	(830)
125,0 (410)	259	(850)

NOTE: Line lengths are based on single part lead line. Hoist line and whip line lengths given in table will allow hook to touch ground. When block travel below ground is required, add additional rope equal to parts of line times added travel distance. Hoisting distance or line pull may be limited when block travel below ground is required.

Maximum load on 26 mm or (1") wire rope is 12 400 kg (27,500 lb) per line. When auxiliary drum is used maximum load is 9 070 kg (20,000 lb).

Performance data

Wire rope specifications 5:1 Safety Factor

Boom No. 78

- or -

Fixed jib No. 134 on boom No. 78

- or -

Luffing jib No. 139 on boom No. 78

- or -

Fixed jib No. 138 on luffing jib No. 139 on boom No. 78

Part number Function	5:1 Safety factor 2160 N/mm ²				
	No. 719379 Hoist line Whip line	No. 719378 Auxiliary line	No. 719413* Hoist line Whip line (High line pull)	No. 719392 Hoist line Whip line	No. 719393 Auxiliary line
Size wire rope	26 mm -	26 mm -	32 mm -	- (1")	- (1")
Minimum breaking strength	656,1 kN (147,500 lb)	650,6 kN (146,200 lb)	1 085,3 kN (244,000 lb)	684,2 kN (153,800 lb)	620,9 kN (139,600 lb)
Maximum load per line	13 380 kg (29,500 lb)	9 070 kg (20,000 lb)	19 960 kg (44,000 lb)	13 380 kg (29,500 lb)	9 070 kg (20,000 lb)
Approximate weight	3,17 kg/m (2.13 lb/ft)	3,17 kg/m (2.13 lb/ft)	4,381 kg/m (3.23 lb/ft)	3,02 kg/m (2.03 lb/ft)	3,02 kg/m (2.03 lb/ft)

* Right Regular Lay

Wire rope specifications 3.5:1 Safety Factor

Boom No. 78

- or -

Fixed jib No. 134 on boom No. 78

- or -

Luffing jib No. 139 on boom No. 78

- or -

Fixed jib No. 138 on luffing jib No. 139 on boom No. 78

Part number Function	3.5:1 Safety Factor Right regular lay, 6x25 filler wire, extra improved plow steel, IWRC			
	No. 719387 Hoist line Whip line Auxiliary line	No. 719060 Hoist line Whip line	No. 719278 Hoist line Whip line (High line pull)	No. 719073 Auxiliary line
Size wire rope	26 mm -	- (1")	- (1-1/4")	- (1")
Minimum breaking strength	483,1 kN (108,600 lb)	460,0 kN (103,400 lb)	72 480 kg (159,800 lb)	40 730 kg (89,890 lb)
Maximum load per line	13 380 kg (29,500 lb)	13 380 kg (29,500 lb)	19 960 kg (44,000 lb)	9 070 kg (20,000 lb)
Approximate weight	2,89 kg/m (1.94 lb/ft)	2,75 kg/m (1.85 lb/ft)	4,30 kg/m (2.89 lb/ft)	2,75 kg/m (1.85 lb/ft)

Performance data

Drums and laggings									
Application	Drums					Optional grooved lagging part number	Lagging diameter	Wire rope size	
	Drum location	Drum part number	Drum type	Drum diameter	Drum width				
Basic liftcrane	Hoist	Front	178272	Bare	495 mm (19-1/2")	765 mm (30-1/8")	502392	540 mm (21-1/4")	26 mm -
							502391	540 mm (21-1/4")	- 1"
	Hoist (optional dual input drive)	Front	178273	Bare	495 mm (19-1/2")	765 mm (30-1/8")	502392	540 mm (21-1/4")	26 mm -
							502391	540 mm (21-1/4")	- 1"
							502395	641 mm (25-1/4")	32 mm OR 1-1/4"
	Whip	Rear	178272	Bare	495 mm (19-1/2")	765 mm (30-1/8")	502392	540 mm (21-1/4")	26 mm -
502391							540 mm (21-1/4")	- 1"	
Whip (optional dual input drive)	Rear	178273	Bare	495 mm (19-1/2")	765 mm (30-1/8")	502392	540 mm (21-1/4")	26 mm -	
Hoist (auxiliary)	Boom Butt	177379	Bare	495 mm (19-1/2")	940 mm (37")	502391	540 mm (21-1/4")	26 mm -	
							540 mm (21-1/4")	- 1"	
Luffing jib liftcrane	Hoist	Front	178272	Bare	495 mm (19-1/2")	765 mm (30-1/8")	502392	540 mm (21-1/4")	26 mm -
							502391	540 mm (21-1/4")	- 1"
	Hoist (optional dual input drive)	Front	178273	Bare	495 mm (19-1/2")	765 mm (30-1/8")	502392	540 mm (21-1/4")	26 mm -
							502391	540 mm (21-1/4")	- 1"
Hoist (auxiliary)	Boom Butt	177379	Bare	495 mm (19-1/2")	940 mm (37")	502372	540 mm (21-1/4")	26 mm -	
						502382	540 mm (21-1/4")	- 1"	
Clamshell	Closing	Front	178272			765 mm (30-1/8")	502410	540 mm (21-1/4")	26 mm OR 1"
	Holding	Rear	178272			765 mm (30-1/8")	502410	540 mm (21-1/4")	26 mm OR 1"
Dragline	Drag	Front	178272			765 mm (30-1/8")	502410	540 mm (21-1/4")	26 mm OR 1"
	Hoist	Rear	178272			765 mm (30-1/8")	502410	540 mm (21-1/4")	26 mm OR 1"

Performance data

Drum capacities - wire rope		
	Maximum length	
	No lagging	With lagging
Front drum (hoist or whip)		
26 mm wire rope	327 m 6 layers	280 m 5 layers*
(1") wire rope	(1,074 ft) 6 layers	(918 ft) 5 layers*
32 mm wire rope	–	145 m 3 layers**
(1-1/4") wire rope	–	(475 ft) 3 layers**
Left rear drum (whip)		
29 mm wire rope	327 m 6 layers	280 m 5 layers*
(1-1/8") wire rope	(1,074 ft) 6 layers	(918 ft) 5 layers*
Auxiliary drum (whip)		
26 mm wire rope	403 m 6 layers	431 m 8 layers*
(1") wire rope	(1,323 ft) 6 layers	(1,415 ft) 8 layers*

NOTE: 5 m (17') is deducted from maximum spooling capacities for 3 dead wraps per drum or lagging.

*Lagging diameter 540 mm (21-1/4").

**Lagging diameter 641 mm (25-1/4").

Main and whip drums - 131 kN (29,500 lb)					
Layer	Full power drum - continuous duty Standard pull/single line speed				
	m/min (ft/min)				
	1	2	3	4	5
Line pull kg (lb)					
0 (0)	99 (325)	108 (354)	117 (383)	126 (413)	135 (442)
2 268 (5,000)	93 (306)	101 (331)	109 (357)	116 (382)	124 (406)
4 536 (10,000)	88 (287)	94 (309)	101 (330)	107 (351)	111 (363)
6 803 (15,000)	75 (245)	76 (249)	77 (252)	78 (256)	79 (260)
9 072 (20,000)	59 (194)	60 (197)	61 (201)	63 (205)	64 (208)
11 340 (25,000)	50 (163)	51 (167)	52 (170)	53 (174)	54 (177)
13 380 (29,500)	44 (144)	45 (148)	46 (151)	47 (155)	48 (158)

NOTE: Line pull is infinitely variable. With 540 mm (21-1/4") lagging for 26 mm or (1") wire rope.

Main and whip drums - 131 kN (29,500 lb)					
Layer	High speed drum - continuous duty Single line pull/single line speed				
	m/min (ft/min)				
	1	2	3	4	5
Line pull kg (lb)					
0 (0)	151 (496)	165 (541)	178 (585)	192 (630)	205 (674)
2 268 (5,000)	141 (462)	152 (500)	164 (537)	175 (574)	186 (611)
4 536 (10,000)	130 (427)	140 (459)	144 (471)	145 (474)	145 (477)
6 803 (15,000)	98 (321)	99 (324)	99 (326)	100 (329)	101 (332)
9 072 (20,000)	76 (249)	77 (251)	77 (254)	78 (257)	79 (260)
11 340 (25,000)	63 (205)	63 (208)	64 (211)	65 (214)	66 (217)
13 380 (29,500)	55 (179)	56 (182)	56 (185)	57 (187)	58 (190)

NOTE: Line pull is infinitely variable. With 540 mm (21-1/4") lagging for 26 mm or (1") wire rope.

Main and whip drums - 196 kN (44,000 lb)			
Layer	High pull drum - continuous duty Single line pull/single line speed		
	m/min (ft/min)		
	1	2	3
Line pull kg (lb)			
0 (0)	119 (389)	130 (425)	141 (462)
2 268 (5,000)	112 (368)	122 (400)	132 (432)
4 536 (10,000)	106 (347)	114 (375)	123 (403)
9 072 (20,000)	74 (242)	74 (244)	75 (246)
13 608 (30,000)	52 (169)	52 (172)	53 (174)
18 143 (40,000)	41 (133)	42 (136)	42 (138)
19 958 (44,000)	38 (123)	38 (126)	39 (128)

NOTE: Line pull is infinitely variable. With 641 mm (25-1/4") lagging for 32 mm or (1-1/4") wire rope.

Performance data

Maximum length – unassisted raising

No. 134 fixed jib on No. 78 main boom Series 2		
Method	Main boom	Fixed jib
Over front of blocked crawlers	m (ft)	–
	82,3 (270)	–
	79,2 (260)	–
	76,2 (250)	–
	73,2 (240)	9,1 (30)
	70,1 (230)	15,2 (50)
	67,1 (220)	24,4 (80)
Over rear of blocked crawlers	79,2 (260)	–
	76,2 (250)	–
	73,2 (240)	–
	70,1 (230)	15,2 (50)
	67,1 (220)	67,1 (70)
	64,0 (210)	24,4 (80)
	70,1 (230)	–
Over side of blocked crawlers	67,1 (220)	–
	64,0 (210)	15,2 (50)
	61,0 (200)	67,1 (70)
	57,9 (190)	24,4 (80)
	70,1 (230)	–

NOTE: Load block(s), hook(s) and weight ball(s) on ground at start.

Maximum length – unassisted raising

No. 139 luffing jib on No. 78 main boom Series 2				
Method	In-line procedure		Jack-knife procedure	
	Main boom	Luffing jib	Main boom	Luffing jib
Over end of blocked crawlers m (ft)	16,8 (55)	15,2 - 36,6 (50 - 120)	16,8 (55)	39,6 - 45,7 (130 - 150)
	19,8 (65)	15,2 - 33,5 (50 - 110)	19,8 (65)	36,6 - 45,7 (120 - 150)
	22,9 (75)	15,2 - 30,5 (50 - 100)	22,9 (75)	33,5 - 45,7 (110 - 150)
	25,9 (85)	15,2 - 24,4 (50 - 80)	25,9 (85)	27,4 - 45,7 (90 - 150)
	29,0 (95)	15,2 - 21,3 (50 - 70)	29,0 (95)	24,4 - 45,7 (80 - 150)
	32,0 (105)	15,2 - 18,3 (50 - 60)	32,0 (105)	21,3 - 45,7 (70 - 150)
	–	–	35,1 (115)	15,2 - 45,7 (50 - 150)
	–	–	38,1 (125)	15,2 - 42,7 (50 - 140)
	–	–	41,1 (135)	15,2 - 30,5 (50 - 100)
	–	–	44,2 (145)	18,3 (60)
	–	–	–	–
	–	–	–	–

NOTE: Load block(s), hook(s) and weight ball(s) on ground at start.

Maximum length – unassisted raising

No. 138 fixed jib on No. 139 luffing jib on No. 78 main boom 777 Series 2 Jack-knife procedure			
Method	Main boom	Luffing jib	Fixed jib
Over end of blocked crawlers m (ft)	54,9 (180)	51,8 (170)	18,3 (60)

NOTE: Load block(s), hook(s) and weight ball(s) on ground at start.

Working weight

Configuration	kg (lb)	
	777 Series 1	777 Series 2
18,3 m (60') No. 78 main boom	118 655 (261,590)	155 450 (342,710)
82,3 m (270') No. 78 main boom combined with 24,4 m (80') No. 134 fixed jib	133 034 (293,290)	169 830 (374,410)

Typical working weight consists of: hydraulic reservoirs full, fuel half-full, drums loaded with standard lengths of wire rope, upper boom point, 160 t (175 USt) hook block, and standard weight ball.

NOTE: Upper boom point not used with fixed jib.

Boom combinations

No. 78 main boom combinations

Boom length m (ft)	Boom inserts		
	3,0 m (10 ft)	6,1 m (20 ft)	12,2 m (40 ft)
18,3 (60)	-	-	-
21,3 (70)	1	-	-
24,4 (80)	-	1	-
27,4 (90)	1	1	-
30,5 (100)	-	-	1
33,5 (110)	1	-	1
36,6 (120)	-	1	1
39,6 (130)	1	1	1
42,7 (140)	-	-	2
45,7 (150)	1	-	2
48,8 (160)	-	1	2
51,8 (170)	1	1	2
54,9 (180)	-	-	3
57,9 (190)	1	-	3
61,0 (200)	-	1	3
64,0 (210)	1	1	3
67,1 (220)	-	-	4
70,1 (230)	1	-	4
73,2 (240)	-	1	4
76,2 (250)	1	1	4
79,2 (260)	-	-	5
82,3 (270)	1	2	4

No. 134 fixed jib combinations

Jib length m (ft)	Fixed jib inserts	
	3,0 m (10 ft)	6,1 m (20 ft)
9,1 (30)	-	-
12,2 (40)	1	-
15,2 (50)	-	1
18,3 (60)	1	1
21,3 (70)	-	2
24,4 (80)	1	2

NOTE: Intermediate suspension required for 57,9 m (190') and longer boom lengths.

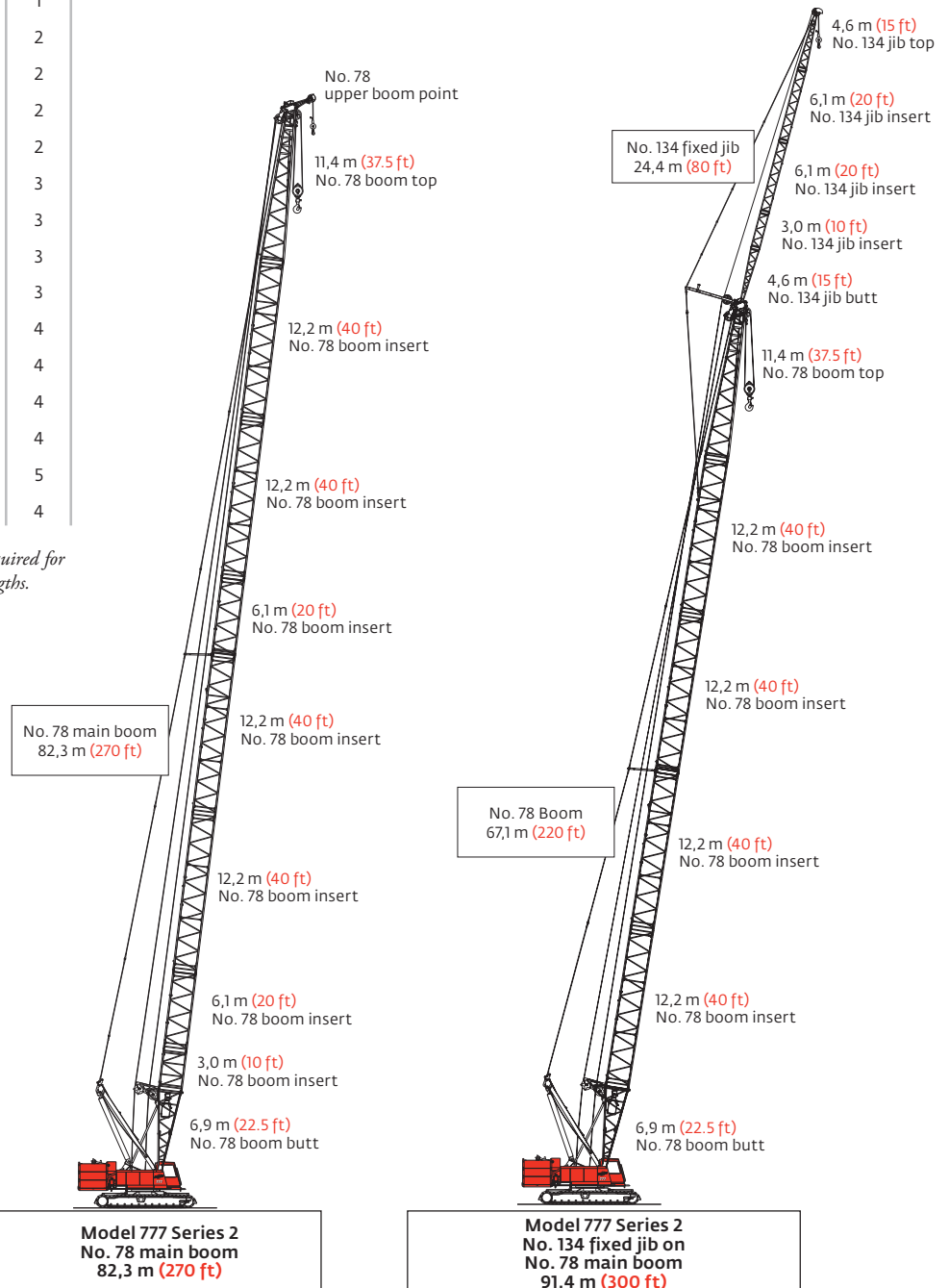

Boom combinations

No. 139 luffing jib combinations

Jib length m (ft)	Luffing jib inserts		
	3,0 m (10 ft)	6,1 m (20 ft)	12,2 m (40 ft)
21,3 (70)	-	1	-
24,4 (80)	1	1	-
27,4 (90)	-	-	1
30,5 (100)	1	-	1
33,5 (110)	-	1	1
36,6 (120)	1	1	1
39,6 (130)	-	-	2
42,7 (140)	1	-	2
45,7 (150)	-	1	2
48,8 (160)	1	1	2
51,8 (170)	0	0	3

No. 138 fixed jib combinations

Jib length m (ft)	Fixed jib inserts
	3,0 m (10 ft)
9,1 (30)	-
12,2 (40)	1
15,2 (50)	2
18,3 (60)	3

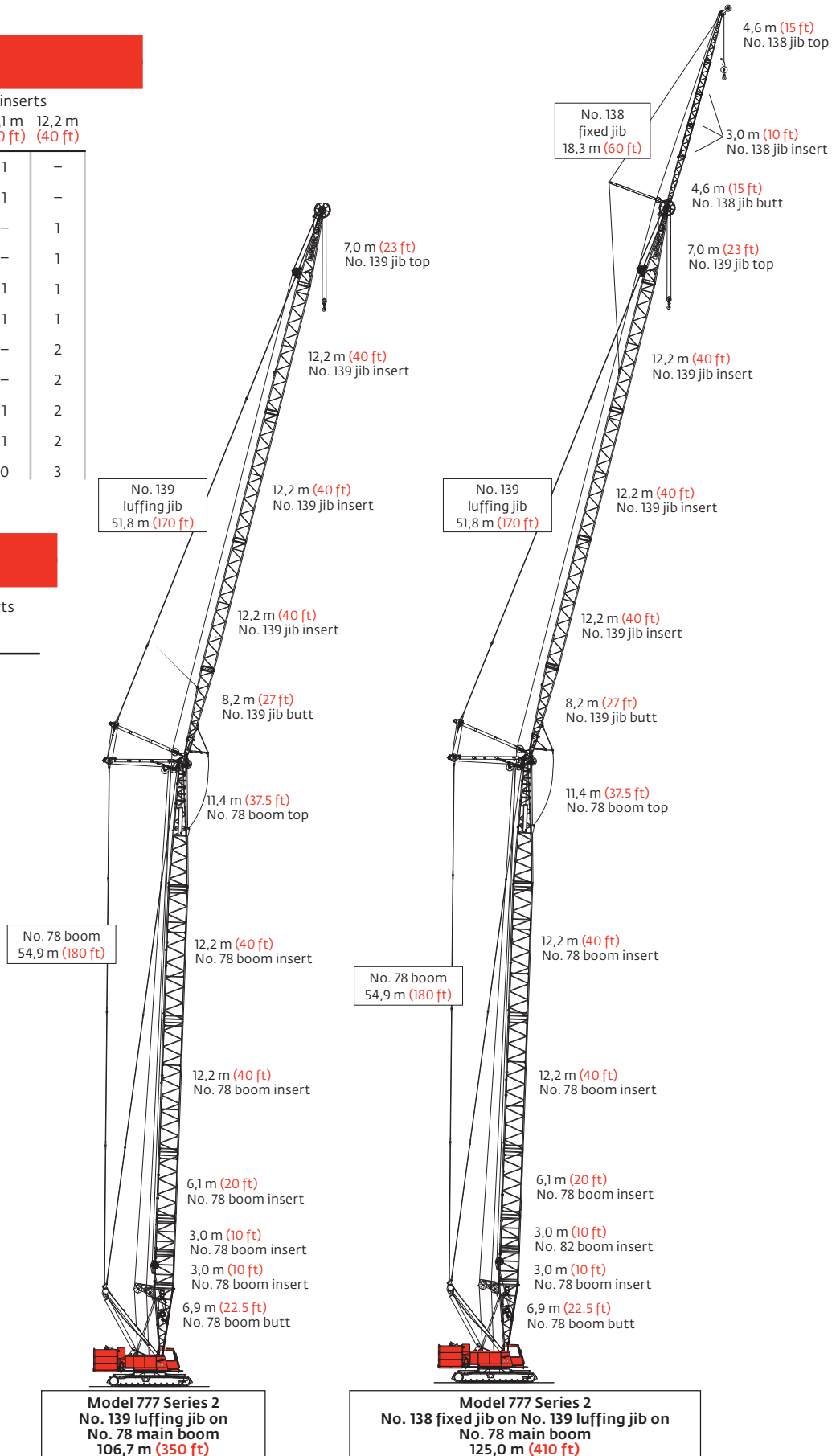

Heavy-lift boom range diagram

No. 78 main boom

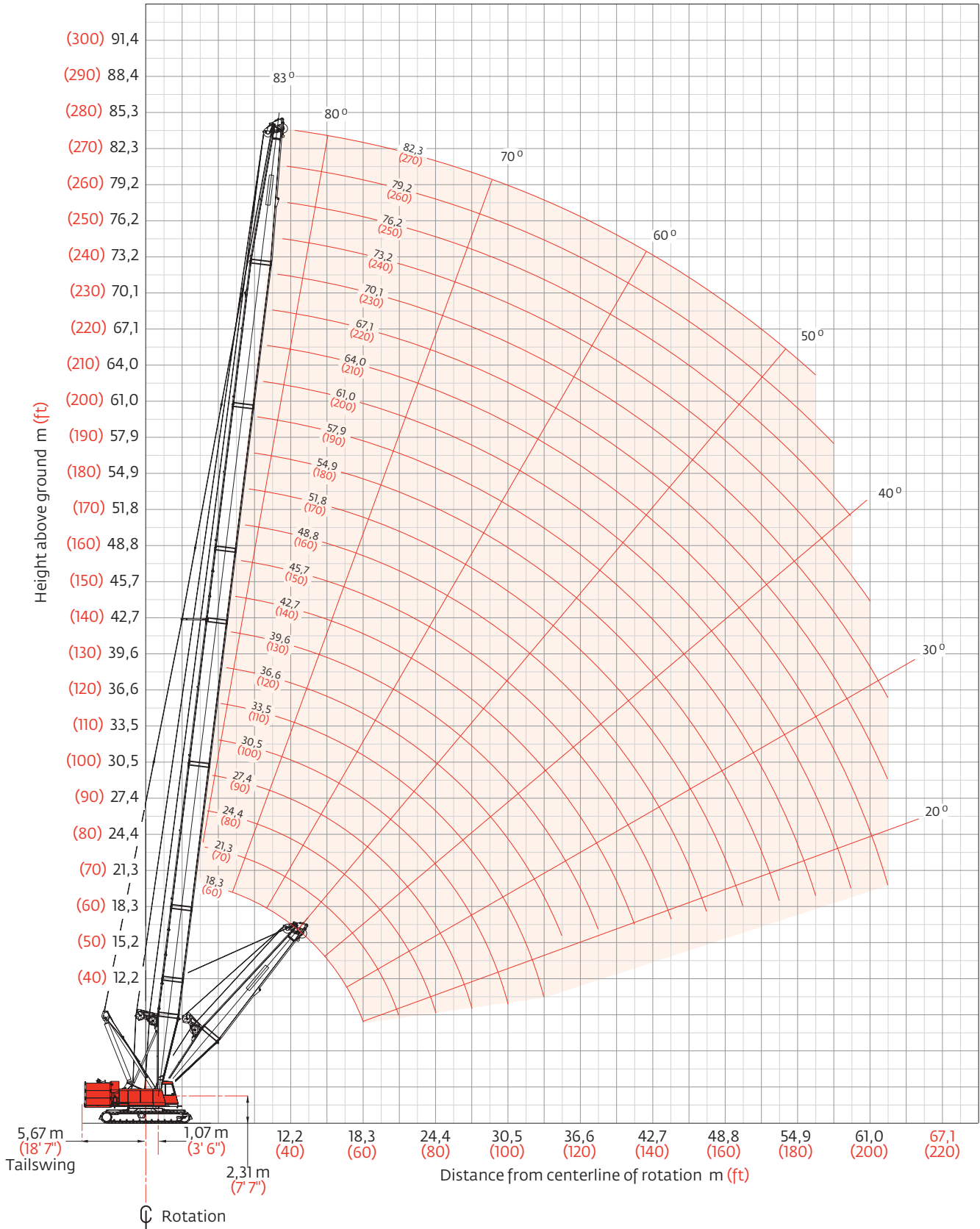

Heavy-lift boom load charts

Liftcrane boom capacities - Series 2

Boom No. 78

64 410 kg (142,000 lb) Counterweight 19 960 kg (44,000 lb) Crawler frame counterweight

360° Rating

kg (lb) x 1 000

Boom m (ft)	18,3 (60)	24,4 (80)	30,5 (100)	36,6 (120)	42,7 (140)	48,8 (160)	51,8 (170)	57,9 (190)	64,0 (210)	70,1 (230)	76,2 (250)	82,3 (270)
Radius												
4,0 (13)	160,0 (352.8)											
4,5 (15)	146,1 (316.7)	– (275.5)										
5,0 (17)	131,9 (281.3)	119,9 (259.9)										
6,0 (20)	110,8 (240.6)	109,6 (239.9)	96,3 (210.7)	– (192.2)								
7,0 (24)	95,2 (201.2)	95,2 (201.0)	89,0 (191.7)	81,5 (175.9)	– (157.9)							
9,0 (30)	74,1 (160.9)	74,0 (160.7)	73,9 (160.2)	70,1 (152.2)	64,3 (140.6)	58,6 (128.1)	56,3 (123.0)	– (116.6)				
10,0 (34)	64,5 (135.0)	65,0 (135.9)	65,1 (136.0)	63,2 (134.7)	60,1 (127.5)	54,9 (118.4)	52,6 (113.4)	50,7 (109.9)	47,3 (102.7)	– (97.1)		
12,0 (40)	49,6 (107.1)	49,9 (107.8)	49,9 (107.8)	50,0 (107.9)	49,8 (107.7)	47,5 (103.2)	46,2 (100.5)	44,2 (96.0)	41,3 (89.7)	39,0 (84.7)	37,1 (80.5)	
14,0 (50)	40,0 (78.4)	40,3 (79.1)	40,3 (79.1)	40,3 (79.1)	40,2 (78.8)	40,2 (78.5)	39,6 (78.3)	37,8 (76.5)	35,6 (72.5)	33,5 (68.0)	31,6 (64.0)	29,6 (59.6)
18,0 (60)	28,1 (60.6)	28,4 (61.5)	28,4 (61.5)	28,4 (61.5)	28,3 (61.1)	28,1 (60.8)	28,0 (60.6)	27,7 (59.8)	27,4 (59.3)	26,0 (56.4)	24,5 (53.3)	22,7 (49.3)
22,0 (70)		21,4 (49.5)	21,5 (49.6)	21,5 (49.6)	21,3 (49.2)	21,2 (48.9)	21,0 (48.6)	20,7 (47.8)	20,4 (47.3)	20,2 (46.7)	19,6 (44.9)	18,2 (41.8)
24,0 (80)		18,9 (40.8)	19,0 (41.0)	19,0 (41.0)	18,8 (40.6)	18,6 (40.3)	18,5 (40.0)	18,2 (39.2)	17,9 (38.7)	17,7 (38.1)	17,4 (37.4)	16,4 (35.5)
26,0 (90)			16,9 (34.5)	16,9 (34.5)	16,7 (34.1)	16,6 (33.8)	16,5 (33.5)	16,1 (32.7)	15,8 (32.2)	15,6 (31.5)	15,2 (30.9)	14,8 (30.1)
30,0 (100)			13,5 (29.2)	13,6 (29.4)	13,4 (29.0)	13,3 (28.7)	13,2 (28.4)	12,8 (27.6)	12,6 (27.1)	12,3 (26.4)	12,0 (25.8)	11,6 (25.0)
34,0 (110)				11,2 (25.3)	11,0 (25.0)	10,9 (24.6)	10,8 (24.4)	10,4 (23.5)	10,1 (23.0)	9,8 (22.3)	9,5 (21.7)	9,2 (20.9)
36,0 (120)					10,0 (21.6)	9,8 (21.2)	9,7 (21.0)	9,3 (20.1)	9,1 (19.6)	8,8 (18.9)	8,5 (18.3)	8,2 (17.5)
40,0 (130)					8,3 (18.7)	8,2 (18.4)	8,1 (18.2)	7,7 (17.3)	7,4 (16.8)	7,1 (16.1)	6,8 (15.5)	6,5 (14.7)
42,0 (140)						7,4 (16.0)	7,3 (15.8)	6,9 (14.9)	6,7 (14.4)	6,4 (13.7)	6,1 (13.1)	5,7 (12.3)
46,0 (150)						6,2 (13.9)	6,1 (13.7)	5,7 (12.8)	5,5 (12.4)	5,1 (11.6)	4,9 (11.0)	4,5 (10.2)
48,0 (160)							5,6 (11.9)	5,1 (11.0)	4,9 (10.6)	4,6 (9.9)	4,3 (9.2)	4,0 (8.4)
52,0 (170)								4,2 (9.4)	4,0 (9.0)	3,7 (8.3)	3,4 (7.6)	2,9 (6.7)
54,0 (180)								3,8 (8.0)	3,6 (7.6)	3,3 (6.9)	2,9 (6.2)	2,5 (5.2)
56,0 (185)								3,3 (7.3)	3,2 (7.0)	2,8 (6.2)	2,6 (5.6)	2,0 (4.4)

For complete chart, refer to www.cranelibrary.com.

Meets ANSI B30.5 Requirements - Capacities do not exceed 75% of static tipping load.
 NOTICE: This capacity chart is for reference only and must not be used for lifting purposes.

Fixed jib range diagram

No. 134 fixed jib on No. 78 main boom

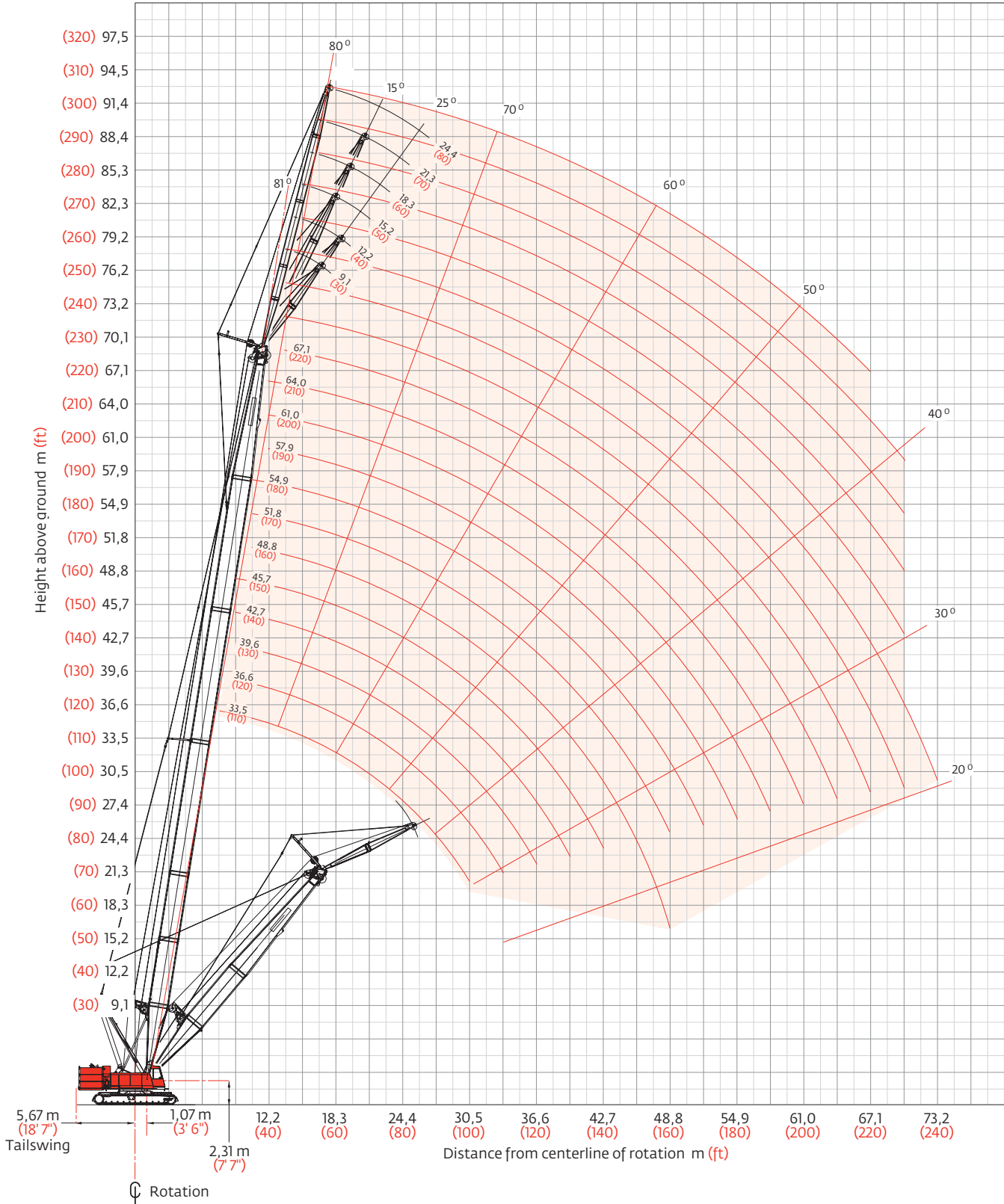

Fixed jib load charts

Liftcrane jib capacities - Series 2

Jib No. 134 with 3 810 mm (12'6") strut on boom No. 78

64 410 kg (142,000 lb) Counterweight 19 960 kg (44,000 lb) Crawler frame counterweight

360° Rating kg (lb) x1 000

		5° offset					25° offset					
		24,4	39,6	51,8	67,1	73,2	24,4	39,6	51,8	67,1	73,2	
		(80)	(130)	(170)	(220)	(240)	(80)	(130)	(170)	(220)	(240)	
Jib 9,1 m (30 ft)	Radius											
	7,6 (25)	26,7 (59,0)					10,0 (35)	– (47,7)				
	10,0 (35)	26,7 (59,0)	– (59,0)				14,0 (50)	19,0 (40,2)	20,9 (44,7)	– (47,0)		
	14,0 (50)	26,6 (58,2)	26,7 (59,0)	26,7 (59,0)	– (58,3)	– (56,8)	18,0 (60)	16,7 (36,6)	18,8 (41,4)	20,1 (44,1)	– (46,5)	– (45,1)
	18,0 (60)	25,3 (55,6)	26,5 (58,5)	26,6 (58,8)	25,8 (56,8)	24,5 (53,5)	20,0 (70)	15,7 (33,7)	18,0 (38,6)	19,2 (41,5)	20,4 (44,1)	19,4 (41,2)
	20,0 (70)	24,5 (51,2)	24,8 (50,0)	24,3 (48,8)	23,4 (47,0)	21,9 (45,1)	24,0 (80)	14,3 (31,4)	16,5 (36,3)	17,9 (39,3)	18,6 (40,2)	17,3 (37,9)
	26,0 (90)	17,6 (36,1)	17,1 (34,8)	16,5 (33,6)	15,6 (31,7)	15,3 (31,0)	26,0 (90)	13,8 (29,7)	15,9 (34,3)	16,9 (34,9)	16,5 (33,4)	16,2 (32,8)
	36,0 (120)		10,3 (22,2)	9,7 (21,0)	8,8 (19,0)	8,5 (18,3)	36,0 (120)		10,6 (22,8)	10,1 (21,8)	9,3 (20,1)	9,1 (19,5)
	44,0 (150)		7,2 (14,9)	6,7 (13,7)	5,8 (11,7)	5,5 (11,0)	40,0 (140)			8,4 (16,3)	7,6 (14,6)	7,3 (14,0)
	52,0 (180)			4,6 (8,9)	3,7 (6,9)	3,4 (6,2)	48,0 (160)			5,7 (12,3)	5,0 (10,6)	4,6 (9,9)
	60,0 (200)				2,2 (4,5)		52,0 (180)				3,9 (7,4)	3,7 (6,8)
	64,0 (210)						60,0 (200)					2,1 (4,3)

		24,4	39,6	51,8	67,1	73,2	24,4	39,6	51,8	67,1	73,2
		(80)	(130)	(170)	(220)	(240)	(80)	(130)	(170)	(220)	(240)
Jib 15,2 m (50 ft)	Radius										
	8,0 (30)	– (43,3)					14,0 (50)	– (30,9)			
	12,0 (40)	18,5 (40,7)	– (43,0)				18,0 (60)	12,6 (27,7)	14,0 (30,7)		
	14,0 (50)	17,8 (38,4)	18,9 (41,1)	19,5 (42,5)			20,0 (70)	11,8 (25,1)	13,3 (28,3)	14,0 (30,2)	– (31,9)
	18,0 (60)	16,6 (36,5)	17,9 (39,4)	18,6 (41,0)	18,1 (40,0)		24,0 (80)	10,5 (23,0)	12,0 (26,4)	12,9 (28,3)	13,7 (30,2)
	20,0 (70)	16,1 (34,8)	17,4 (37,8)	18,1 (39,6)	17,8 (39,0)		26,0 (90)	10,0 (21,3)	11,5 (24,7)	12,4 (26,7)	13,3 (28,7)
	26,0 (90)	14,7 (31,9)	16,2 (35,2)	16,9 (34,4)	16,0 (32,5)		36,0 (120)		9,5 (20,9)	10,4 (22,9)	10,0 (21,5)
	36,0 (120)	11,3 (24,5)	10,6 (23,0)	10,0 (21,6)	9,1 (19,7)		40,0 (140)		9,0 (18,5)	8,9 (17,5)	8,2 (15,9)
	44,0 (150)		7,6 (15,7)	7,0 (14,3)	6,0 (12,3)		48,0 (160)			6,2 (13,3)	5,4 (11,6)
	52,0 (180)		5,4	4,9 (9,5)	3,9 (7,5)		52,0 (180)			5,2	4,4 (8,4)
	60,0 (200)			3,3 (7,1)	2,4 (5,1)		60,0 (200)				2,8 (5,8)
	64,0 (220)			2,7	1,8		64,0 (210)				2,1 (4,7)

For complete chart, refer to www.cranelibrary.com.

Meets ANSI B30.5 Requirements - Capacities do not exceed 75% of static tipping load.
 NOTICE: This capacity chart is for reference only and must not be used for lifting purposes.

Fixed jib load charts

Liftcrane jib capacities - Series 2

Jib No. 134 with 3 810 mm (12'6") strut on boom No. 78

64 410 kg (142,000 lb) Counterweight 19 960 kg (44,000 lb) Crawler frame counterweight

360° Rating

kg (lb) x 1 000

5° offset

Boom m (ft)	24,4 (80)	39,6 (130)	51,8 (170)	67,1 (220)	73,2 (240)
Radius 10,0 (35)	- (35.3)				
14,0 (50)	15,0 (32.5)	15,9 (34.5)	16,4 (35.6)		
18,0 (60)	14,0 (30.9)	15,0 (33.1)	15,6 (34.4)	15,5 (34.1)	
24,0 (80)	12,7 (27.9)	13,9 (30.7)	14,6 (32.2)	14,7 (32.5)	
28,0 (100)	11,9 (25.5)	13,2 (28.4)	14,0 (29.4)	14,1 (27.5)	
36,0 (120)	9,9 (21.5)	10,7 (23.2)	10,1 (21.8)	9,2 (19.9)	
40,0 (140)	8,8 -	9,1 (18.0)	8,4 (16.6)	7,5 (14.6)	
48,0 (160)		6,6 (14.1)	5,9 (12.7)	5,0 (10.6)	
56,0 (190)		4,7 -	4,1 (8.4)	3,2 (6.4)	
64,0 (210)			2,8 (6.2)	1,9 (4.2)	
68,0 (230)					

25° offset

Boom m (ft)	24,4 (80)	39,6 (130)	51,8 (170)	67,1 (220)	73,2 (240)
Radius 16,0 (55)	- (25.4)				
18,0 (65)	11,3 (24.0)	- (25.2)			
22,0 (75)	10,0 (21.6)	11,2 (24.4)	11,4 (25.1)	- (25.5)	
26,0 (90)	8,9 (19.0)	10,2 (21.8)	11,0 (23.6)	11,3 (24.7)	
32,0 (110)	7,7 (16.4)	8,9 (19.2)	9,7 (21.0)	10,5 (22.8)	
36,0 (130)	7,0 -	8,3 (17.3)	9,1 (19.0)	9,8 (18.9)	
44,0 (150)		7,3 (15.8)	7,5 (15.7)	7,0 (14.2)	
48,0 (170)		6,8 -	6,4 (12.1)	5,7 (10.4)	
56,0 (190)			4,5 (9.1)	3,8 (7.5)	
64,0 (210)				2,3 (5.1)	
- (220)				- (4.1)	

Boom m (ft)	24,4 (80)	39,6 (130)	51,8 (170)	67,1 (220)	73,2 (240)
Radius 10,0 (35)	- (20.6)				
14,0 (50)	9,1 (20.1)	9,3 (20.5)	- (20.6)		
18,0 (65)	8,9 (19.6)	9,1 (20.1)	9,2 (20.3)	9,3 (20.5)	
24,0 (80)	8,4 (18.4)	8,9 (19.7)	9,0 (20.0)	9,1 (20.2)	
28,0 (100)	7,8 (16.6)	8,7 (18.6)	8,9 (19.6)	9,0 (19.8)	
36,0 (130)	6,8 (14.3)	7,8 (16.5)	8,3 (17.8)	8,4 (17.2)	
48,0 (160)	5,8 (12.7)	6,6 (14.4)	6,0 (12.9)	5,0 (10.8)	
56,0 (190)		4,9 (10.2)	4,2 (8.7)	3,3 (6.6)	
64,0 (210)			2,9 (6.6)	2,0 (4.5)	
68,0 (230)			2,4 (4.8)		
72,0 (240)			1,9 (4.0)		

Boom m (ft)	24,4 (80)	39,6 (130)	51,8 (170)	67,1 (220)	73,2 (240)
Radius 20,0 (70)	- (17.2)				
24,0 (80)	7,7 (16.8)	- (17.4)			
26,0 (90)	7,3 (16.0)	7,6 (16.8)	- (17.2)		
32,0 (110)	7,1 (15.2)	7,4 (16.2)	7,7 (16.7)	7,8 (17.1)	
36,0 (130)	6,0 (12.8)	6,9 (15.0)	7,2 (15.8)	7,4 (16.3)	
44,0 (150)	5,4 (11.1)	6,4 (13.2)	6,9 (14.5)	7,2 (15.6)	
48,0 (170)	4,6 -	5,5 (11.8)	6,1 (13.1)	6,7 (14.3)	
56,0 (190)		5,1 (10.7)	5,7 (12.0)	5,8 (11.0)	
64,0 (210)			4,6 (9.6)	4,0 (8.0)	
68,0 (230)			3,3 (7.3)	2,4 (5.4)	

For complete chart, refer to www.cranelibrary.com.

Meets ANSI B30.5 Requirements - Capacities do not exceed 75% of static tipping load.
NOTICE: This capacity chart is for reference only and must not be used for lifting purposes.

Luffing jib range diagram

No. 134 fixed jib on No. 78 main boom

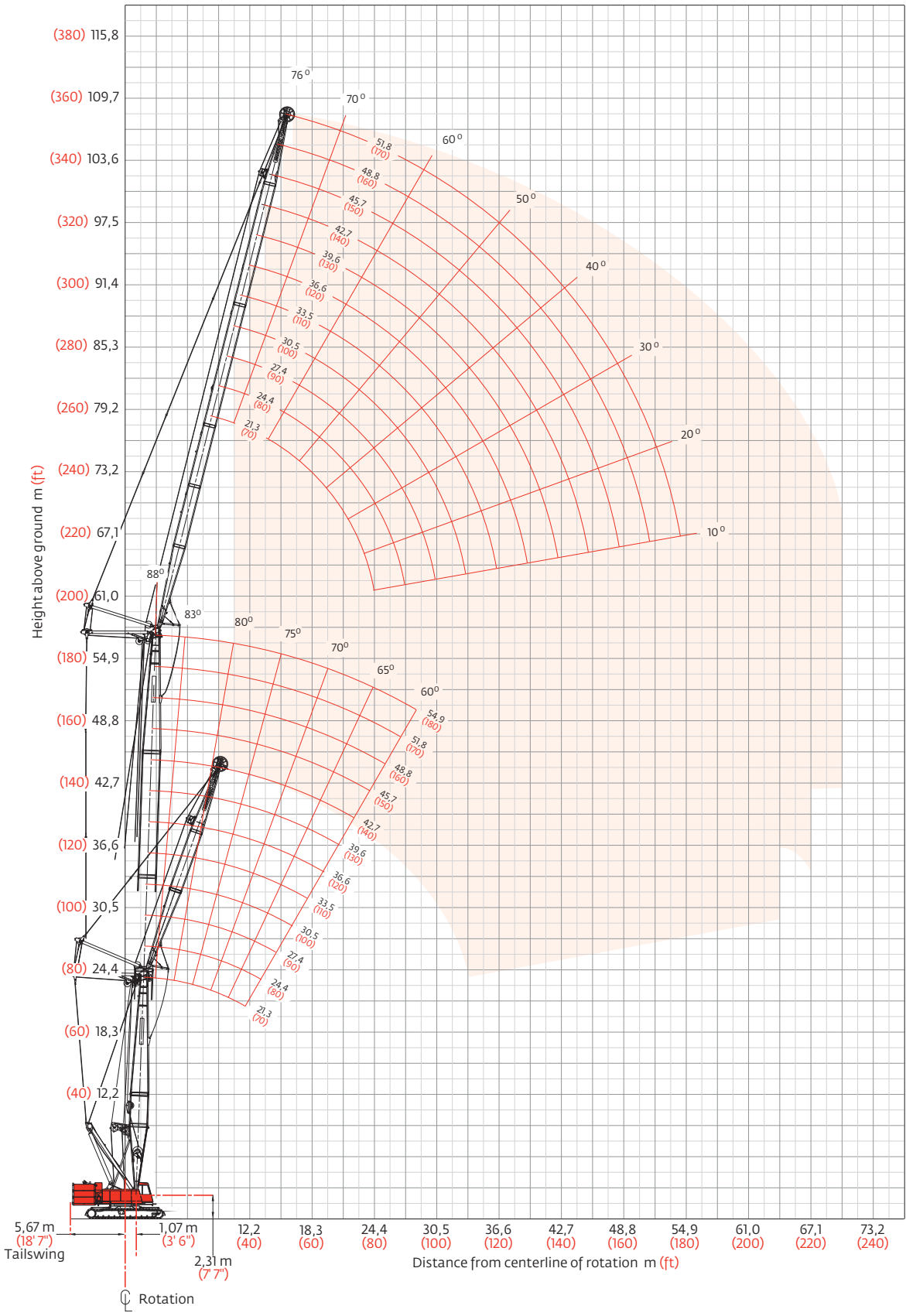

Luffing jib load charts

Liftcrane luffing jib capacities - Series 2

Luffing jib No. 139 on boom No. 78

64 410 kg (142,000 lb) Counterweight 19 960 kg (44,000 lb) Carbody counterweight

360° Rating

kg (lb) x 1 000

88° boom angle

Boom m (ft)	21,3 (70)	30,5 (100)	39,6 (130)	45,7 (150)	54,9 (180)
Radius 9,1 (30)	47,4 (104.6)				
12,0 (40)	43,2 (94.7)	42,9 (94.0)	41,2 (90.3)	37,2 (81.4)	– (71.4)
14,0 (50)	37,4 (73.5)	38,7 (76.2)	37,7 (78.1)	34,2 (71.9)	30,3 (63.9)
20,0 (70)	23,1 (46.6)	23,8 (48.0)	24,4 (49.2)	25,0 (50.2)	24,2 (49.4)
26,0 (90)					
32,0 (110)					
38,0 (130)					
44,0 (150)					
50,0 (170)					
54,0 (180)					

Boom m (ft)	21,3 (70)	30,5 (100)	39,6 (130)	45,7 (150)	54,9 (180)
Radius 9,1 (30)					
12,0 (40)	33,3 (73.0)	32,7 (71.9)	31,6 (69.6)	30,6 (67.4)	– (51.7)
14,0 (50)	31,1 (66.2)	31,1 (66.1)	30,4 (65.4)	29,6 (63.9)	22,9 (49.8)
20,0 (70)	23,3 (47.3)	24,0 (48.6)	24,6 (49.8)	24,6 (50.2)	20,6 (43.6)
26,0 (90)	16,3 (33.4)	16,7 (34.2)	17,1 (34.9)	17,3 (35.4)	16,5 (34.5)
32,0 (110)	11,3 (–)	11,7 (–)	12,2 (–)	12,4 (–)	12,8 (23.3)
38,0 (130)					
44,0 (150)					
50,0 (170)					
54,0 (180)					

Boom m (ft)	21,3 (70)	30,5 (100)	39,6 (130)	45,7 (150)	54,9 (180)
Radius 9,1 (30)					
12,0 (40)	– (51.7)	– (49.9)			
14,0 (50)	22,7 (49.0)	22,1 (48.0)	21,1 (46.0)	20,4 (44.5)	18,8 (40.7)
20,0 (70)	19,3 (41.0)	19,4 (41.2)	19,2 (41.1)	19,1 (40.9)	16,8 (35.9)
26,0 (90)	16,2 (33.6)	16,4 (34.4)	16,5 (35.1)	16,5 (35.2)	14,3 (30.4)
32,0 (110)	12,1 (25.0)	12,4 (25.6)	12,7 (26.1)	12,8 (26.4)	11,9 (25.0)
38,0 (130)	9,2 (19.1)	9,5 (19.6)	9,7 (19.9)	9,7 (20.1)	9,8 (20.5)
44,0 (150)					
50,0 (170)					
54,0 (180)					

Boom m (ft)	21,3 (70)	30,5 (100)	39,6 (130)	45,7 (150)	54,9 (180)
Radius 9,1 (30)					
12,0 (40)					
14,0 (50)	– (35.6)	– (34.3)			
20,0 (70)	13,8 (29.2)	13,8 (29.3)	13,7 (29.1)	12,2 (26.0)	11,8 (25.6)
26,0 (90)	11,2 (23.6)	11,3 (23.9)	11,4 (24.1)	10,2 (21.6)	10,2 (21.7)
32,0 (110)	9,0 (18.9)	9,2 (19.3)	9,3 (19.5)	8,4 (17.6)	8,5 (17.9)
38,0 (130)	7,2 (15.1)	7,4 (15.4)	7,5 (15.7)	6,8 (14.3)	7,0 (14.6)
44,0 (150)	5,7 (12.0)	5,9 (12.3)	6,0 (12.5)	5,5 (11.5)	5,6 (11.8)
50,0 (170)	4,4 (8.8)	4,5 (9.1)	4,6 (9.3)	4,2 (8.5)	4,3 (8.8)
54,0 (180)					3,5 (7.5)

For complete chart, refer to www.cranelibrary.com.

Meets ANSI B30.5 Requirements - Capacities do not exceed 75% of static tipping load.
NOTICE: This capacity chart is for reference only and must not be used for lifting purposes.

Luffing jib load charts

Liftcrane luffing jib capacities - Series 2

Luffing jib No. 139 on boom No. 78

64 410 kg (142,000 lb) Counterweight 19 960 kg (44,000 lb) Carbody counterweight

360° Rating

kg (lb) x 1 000

75° boom angle

Luffing jib length 21,3 m (70 ft)	Boom m (ft)	21,3 (70)	30,5 (100)	39,6 (130)	45,7 (150)	54,9 (180)
	Radius					
16,0 (55)		- (71.7)				
18,0 (65)		29,8 (58.2)	- (55.9)			
26,0 (90)		18,8 (38.8)	18,0 (37.3)	17,1 (35.3)	16,4 (33.9)	15,3 (31.6)
32,0 (110)				13,1 -	12,6 (26.2)	11,7 (24.4)
38,0 (130)						
44,0 (150)						
50,0 (170)						
56,0 (190)						
62,0 (210)						
66,0 (220)						

Luffing jib length 30,5 m (100 ft)	Boom m (ft)	21,3 (70)	30,5 (100)	39,6 (130)	45,7 (150)	54,9 (180)
	Radius					
16,0 (55)						
18,0 (65)						
26,0 (90)		18,4 (38.0)	17,6 (36.3)	16,6 (34.3)	- (32.8)	
32,0 (110)		14,1 (29.4)	13,5 (28.1)	12,7 (26.4)	12,1 (25.3)	11,2 (23.3)
38,0 (130)			10,7 (22.4)	10,1 (21.1)	9,6 (20.2)	8,9 (18.6)
44,0 (150)						7,2 (15.1)
50,0 (170)						
56,0 (190)						
62,0 (210)						
66,0 (220)						

Luffing jib length 39,6 m (130 ft)	Boom m (ft)	21,3 (70)	30,5 (100)	39,6 (130)	45,7 (150)	54,9 (180)
	Radius					
16,0 (55)						
18,0 (65)						
26,0 (90)		18,1 (37.4)	- (35.6)			
32,0 (110)		13,8 (28.8)	13,2 (27.4)	12,4 (25.7)	11,8 (24.5)	
38,0 (130)		11,0 (23.1)	10,5 (21.9)	9,8 (20.5)	9,3 (19.5)	8,6 (17.8)
44,0 (150)		8,9 (18.3)	8,5 (17.9)	8,0 (16.7)	7,6 (15.9)	6,9 (14.5)
50,0 (170)				6,6 -	6,2 (13.1)	5,7 (11.9)
56,0 (190)						
62,0 (210)						
66,0 (220)						

Luffing jib length 51,8 m (170 ft)	Boom m (ft)	21,3 (70)	30,5 (100)	39,6 (130)	45,7 (150)	54,9 (180)
	Radius					
16,0 (55)						
18,0 (65)						
26,0 (90)						
32,0 (110)		10,7 (22.6)	- (24.3)			
38,0 (130)		8,7 (18.2)	9,5 (19.9)	9,3 (19.4)	- (18.4)	- (16.7)
44,0 (150)		6,9 (14.5)	7,7 (16.0)	7,5 (15.7)	7,1 (14.8)	6,4 (13.3)
50,0 (170)		5,5 (11.4)	6,1 (12.8)	6,1 (12.9)	5,8 (12.1)	5,2 (10.8)
56,0 (190)		4,1 (8.3)	4,7 (9.5)	5,1 (10.7)	4,8 (10.0)	4,2 (8.7)
62,0 (210)				4,0 -	3,9 (8.0)	3,3 (6.9)
66,0 (220)						2,9 (6.2)

For complete chart, refer to www.cranelibrary.com.

Meets ANSI B30.5 Requirements - Capacities do not exceed 75% of static tipping load.
NOTICE: This capacity chart is for reference only and must not be used for lifting purposes.

Luffing jib load charts

Liftcrane luffing jib capacities - Series 2

Luffing jib No. 139 on boom No. 78

64 410 kg (142,000 lb) Counterweight 19 960 kg (44,000 lb) Carbody counterweight

360° Rating kg (lb) x 1000

60° boom angle

	Boom m (ft)					Boom m (ft)				
	21,3 (70)	30,5 (100)	39,6 (130)	45,7 (150)	54,9 (180)	21,3 (70)	30,5 (100)	39,6 (130)	45,7 (150)	54,9 (180)
Luffing jib length 21,3 m (70 ft)	Radius 26,0 (90)	- (34.7)								
	30,0 (100)	14,0 (30.3)								
	32,0 (110)	12,9 (26.7)	11,6 (24.1)							
	36,0 (120)		9,9 (21.5)	- (18.7)						
	38,0 (130)		9,2 -	8,0 (16.7)	- (14.8)					
	44,0 (150)				5,7 (11.9)	- (9.3)				
	50,0 (170)					3,5 -				
	56,0 (190)									
	64,0 (210)									
	70,0 (230)									
Luffing jib length 30,5 m (100 ft)	Radius 26,0 (90)									
	30,0 (100)									
	32,0 (110)					- (25.9)				
	36,0 (120)					10,6 (23.1)				
	38,0 (130)					9,9 (20.7)	- (18.3)			
	44,0 (150)						7,1 (14.8)	6,0 (12.5)	- (10.8)	
	50,0 (170)							4,9 (10.2)	4,2 (8.7)	- (6.3)
	56,0 (190)									2,4 (4.9)
	64,0 (210)									
	70,0 (230)									

70° boom angle

	Boom m (ft)					Boom m (ft)				
	21,3 (70)	30,5 (100)	39,6 (130)	45,7 (150)	54,9 (180)	21,3 (70)	30,5 (100)	39,6 (130)	45,7 (150)	54,9 (180)
Luffing jib length 39,6 m (130 ft)	Radius 26,0 (90)									
	30,0 (100)	- (31.2)								
	32,0 (110)	13,2 (27.6)	- (25.6)							
	36,0 (120)	11,3 (24.6)	10,5 (22.8)	- (20.7)						
	38,0 (130)	10,5 (22.0)	9,7 (20.4)	8,8 (18.5)	- (17.1)					
	44,0 (150)	8,6 (18.0)	7,9 (16.6)	7,2 (15.0)	6,6 (13.8)	5,7 (11.9)				
	50,0 (170)		6,5 -	5,9 (12.4)	5,4 (11.3)	4,6 (9.7)				
	56,0 (190)				4,5 -	3,8 (7.9)				
	64,0 (210)									
	70,0 (230)									
Luffing jib length 51,8 m (170 ft)	Radius 26,0 (90)									
	30,0 (100)									
	32,0 (110)									
	36,0 (120)					- (21.4)				
	38,0 (130)					9,2 (19.3)	- (19.3)			
	44,0 (150)					7,4 (15.5)	7,4 (15.6)	6,6 (13.9)	- (12.7)	
	50,0 (170)					5,9 (12.3)	6,1 (12.8)	5,4 (11.3)	4,9 (10.2)	4,1 (8.5)
	56,0 (190)					4,5 (9.1)	5,0 (10.6)	4,4 (9.3)	4,0 (8.3)	3,3 (6.8)
	64,0 (210)							3,4 (7.6)	3,0 (6.8)	2,4 (5.4)
	70,0 (230)									1,9 (4.2)

For complete chart, refer to www.cranelibrary.com.

Meets ANSI B30.5 Requirements - Capacities do not exceed 75% of static tipping load.
NOTICE: This capacity chart is for reference only and must not be used for lifting purposes.

Fixed jib on luffing jib range diagram

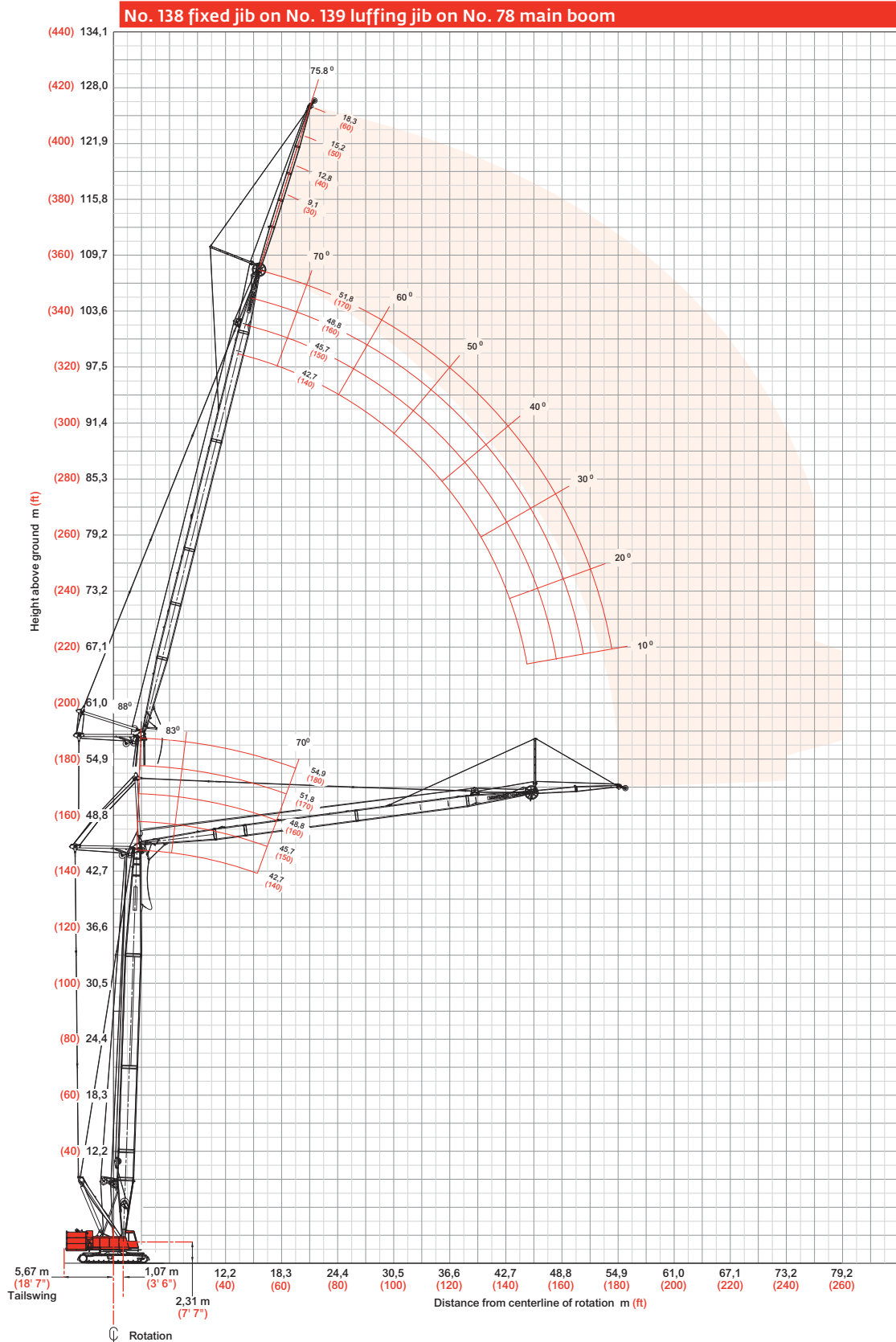

Meets ANSI B30.5 Requirements - Capacities do not exceed 75% of static tipping load.
 NOTICE: This capacity chart is for reference only and must not be used for lifting purposes.

Fixed jib on luffing jib load charts

Liftcrane fixed jib on luffing jib capacities - Series 2

Fixed jib No. 138 at 3 degree angle on luffing jib No. 139 on boom No. 78

64 410 kg (142,000 lb) Upperworks counterweight 19 960 kg (44,000 lb) Carbody counterweight

360° Rating

kg (lb) x 1 000

88° boom angle

	Luffing jib m (ft)			42,7 (140)			45,7 (150)			48,8 (160)			51,8 (170)		
	Boom m (ft)	42,7 (140)	48,8 (160)	54,9 (180)	42,7 (140)	48,8 (160)	54,9 (180)	42,7 (140)	48,8 (160)	54,9 (180)	42,7 (140)	48,8 (160)	54,9 (180)		
Fixed jib length 9,1 m (30 ft)	Radius														
	16,8 (55)	12,2 (27.0)	12,0 (26.6)												
	20,0 (70)	12,0 (26.2)	11,8 (25.9)	11,6 (25.4)	11,7 (25.7)	11,2 (24.7)	10,6 (23.4)	10,5 (23.0)	10,1 (22.1)	9,6 (21.0)	9,4 (20.6)	9,0 (19.8)	8,6 (18.8)		
	24,0 (80)	11,6 (25.7)	11,5 (25.4)	11,0 (24.3)	11,4 (25.1)	10,9 (24.1)	10,2 (22.5)	10,2 (22.5)	9,8 (21.6)	9,3 (20.6)	9,1 (20.1)	8,7 (19.3)	8,3 (18.4)		
	30,0 (100)	10,0 (21.9)	10,0 (22.0)	9,8 (21.5)	9,8 (21.5)	9,8 (21.5)	9,2 (20.2)	9,6 (21.0)	9,2 (20.2)	8,5 (18.7)	8,6 (19.0)	8,3 (18.3)	7,9 (17.3)		
	36,0 (120)	8,7 (19.1)	8,8 (19.2)	8,5 (18.6)	8,6 (18.8)	8,6 (18.8)	8,1 (17.7)	8,4 (18.5)	8,2 (18.0)	7,6 (16.7)	8,1 (17.8)	7,7 (16.8)	7,1 (15.6)		
	42,0 (140)	7,7 (16.9)	7,8 (17.0)	7,2 (15.7)	7,6 (16.7)	7,6 (16.5)	7,0 (15.2)	7,5 (16.5)	7,2 (15.8)	6,7 (14.6)	7,3 (16.0)	6,8 (15.0)	6,3 (13.8)		
	48,0 (160)	6,6 (14.2)	6,5 (14.2)	6,1 (13.2)	6,6 (14.1)	6,4 (14.0)	6,0 (13.0)	6,4 (13.9)	6,3 (13.7)	5,8 (12.6)	6,3 (13.6)	6,0 (13.1)	5,5 (12.1)		
	54,0 (180)	4,9 (9.7)	5,0 (10.0)	5,0 (10.3)	5,2 (11.1)	5,2 (11.2)	5,0 (11.0)	5,1 (10.9)	5,1 (11.0)	5,0 (10.8)	5,0 (10.7)	5,0 (10.8)	4,9 (10.6)		
	60,0 (200)							3,8 (7.2)	3,8 (7.5)	3,9 (7.7)	3,8 (8.2)	3,9 (8.3)	3,9 (8.4)		
	64,0 (210)										2,7 (6.1)	2,8 (6.3)	2,9 (6.5)		

	Luffing jib m (ft)			42,7 (140)			45,7 (150)			48,8 (160)			51,8 (170)		
	Boom m (ft)	42,7 (140)	48,8 (160)	54,9 (180)	42,7 (140)	48,8 (160)	54,9 (180)	42,7 (140)	48,8 (160)	54,9 (180)	42,7 (140)	48,8 (160)	54,9 (180)		
Fixed jib length 18,3 m (60 ft)	Radius														
	20,0 (65)	7,1 (15.7)	6,9 (15.4)	6,8 (15.1)	6,8 (15.1)	6,6 (14.8)									
	24,0 (80)	6,7 (14.8)	6,6 (14.6)	6,5 (14.3)	6,5 (14.3)	6,3 (14.0)	6,2 (13.7)	6,2 (13.7)	6,1 (13.4)	5,9 (13.0)	5,8 (12.9)	5,7 (12.6)	5,6 (12.3)		
	30,0 (100)	6,2 (13.6)	6,1 (13.5)	6,0 (13.3)	6,0 (13.2)	5,9 (13.0)	5,8 (12.8)	5,7 (12.7)	5,6 (12.5)	5,5 (12.2)	5,5 (12.1)	5,4 (11.9)	5,2 (11.6)		
	36,0 (120)	5,7 (12.6)	5,6 (12.5)	5,6 (12.4)	5,6 (12.3)	5,5 (12.2)	5,4 (12.0)	5,4 (11.9)	5,3 (11.7)	5,2 (11.5)	5,1 (11.4)	5,0 (11.2)	4,9 (10.9)		
	42,0 (140)	5,1 (11.2)	5,2 (11.3)	5,2 (11.4)	5,0 (11.0)	5,1 (11.1)	5,1 (11.2)	5,0 (10.9)	5,0 (10.9)	4,9 (10.9)	4,8 (10.6)	4,8 (10.6)	4,7 (10.4)		
	48,0 (160)	4,5 (9.9)	4,6 (10.0)	4,6 (10.1)	4,5 (9.8)	4,5 (9.8)	4,5 (9.9)	4,4 (9.6)	4,4 (9.7)	4,4 (9.7)	4,3 (9.4)	4,3 (9.5)	4,3 (9.5)		
	54,0 (180)	4,1 (8.9)	4,1 (9.0)	4,1 (9.0)	4,0 (8.8)	4,0 (8.8)	4,0 (8.9)	3,9 (8.7)	3,9 (8.7)	4,0 (8.8)	3,9 (8.5)	3,9 (8.6)	3,9 (8.6)		
	58,0 (200)	3,8 (8.1)	3,8 (8.2)	3,8 (8.1)	3,8 (8.0)	3,8 (8.1)	3,8 (8.1)	3,7 (7.9)	3,7 (7.9)	3,8 (8.0)	3,6 (7.8)	3,6 (7.8)	3,7 (7.8)		
	64,0 (220)	3,3 -	3,4 -	3,4 -	3,4 (6.4)	3,4 (6.7)	3,4 (6.9)	3,4 (7.3)	3,4 (7.3)	3,4 (7.0)	3,3 (7.1)	3,4 (7.2)	3,3 (6.9)		
	72,0 (240)										2,4 (4.4)	2,5 (4.7)	2,5 (4.8)		

For complete chart, refer to www.cranelibrary.com.

Meets ANSI B30.5 Requirements - Capacities do not exceed 75% of static tipping load.
 NOTICE: This capacity chart is for reference only and must not be used for lifting purposes.

Fixed jib on luffing jib load charts

Liftcrane fixed jib on luffing jib capacities - Series 2

Fixed jib No. 138 at 3 degree angle on luffing jib No. 139 on boom No. 78

64 410 kg (142,000 lb) Upperworks counterweight 19 960 kg (44,000 lb) Carbody counterweight

360° Rating

kg (lb) x1 000

83° boom angle

Fixed jib length 9,1 m (30 ft)	Luffing jib m (ft)			42,7 (140)			45,7 (150)			48,8 (160)			51,8 (170)		
	Boom m (ft)	42,7 (140)	48,8 (160)	54,9 (180)	42,7 (140)	48,8 (160)	54,9 (180)	42,7 (140)	48,8 (160)	54,9 (180)	42,7 (140)	48,8 (160)	54,9 (180)		
	Radius 24,0 (80)	- (26.4)													
26,0 (90)	11,8 (26.0)	11,7 (25.7)	11,1 (24.6)	11,1 (24.5)	- (23.4)	- (22.0)	- (21.7)	- (20.7)			- (19.3)				
30,0 (100)	11,2 (24.5)	11,4 (25.0)	11,0 (24.4)	10,9 (23.9)	10,4 (23.1)	9,9 (21.9)	9,7 (21.4)	9,3 (20.5)	8,8 (19.5)		8,6 (19.0)	8,2 (18.2)	7,9 (17.4)		
36,0 (120)	9,6 (21.0)	9,8 (21.5)	10,0 (21.9)	9,4 (20.6)	9,6 (21.0)	9,7 (21.4)	9,2 (20.2)	9,0 (19.9)	8,6 (19.0)		8,3 (18.2)	8,0 (17.6)	7,6 (16.9)		
42,0 (140)	8,4 (18.4)	8,6 (18.8)	8,2 (17.8)	8,3 (18.1)	8,4 (18.5)	8,1 (17.5)	8,1 (17.8)	8,3 (18.1)	7,9 (17.1)		7,8 (17.2)	7,7 (17.0)	7,4 (16.4)		
48,0 (160)	7,5 (16.4)	7,1 (15.4)	6,6 (14.3)	7,4 (16.2)	7,0 (15.2)	6,5 (14.1)	7,3 (15.8)	6,8 (14.7)	6,3 (13.7)		7,0 (15.4)	6,7 (14.4)	6,2 (13.3)		
54,0 (180)	6,1 (13.0)	5,9 (12.6)	5,4 (11.7)	6,1 (13.0)	5,8 (12.4)	5,3 (11.5)	5,9 (12.7)	5,5 (12.0)	5,1 (11.0)		5,8 (12.5)	5,4 (11.6)	5,0 (10.7)		
60,0 (200)				4,7 (10.1)	4,7 (10.2)	4,4 (9.4)	4,7 (10.0)	4,5 (9.8)	4,1 (8.9)		4,6 (9.8)	4,4 (9.4)	4,0 (8.6)		
62,0 (210)					4,3 (-)	4,1 (-)	4,3 (8.7)	4,2 (8.8)	3,9 (8.1)		4,2 (8.6)	4,1 (8.5)	3,7 (7.7)		
64,0 (220)							3,9 (-)	3,9 (-)	3,6 (-)		3,9 (7.4)	3,8 (7.6)	3,4 (6.9)		

Fixed jib length 18,3 m (60 ft)	Luffing jib m (ft)			42,7 (140)			45,7 (150)			48,8 (160)			51,8 (170)		
	Boom m (ft)	42,7 (140)	48,8 (160)	54,9 (180)	42,7 (140)	48,8 (160)	54,9 (180)	42,7 (140)	48,8 (160)	54,9 (180)	42,7 (140)	48,8 (160)	54,9 (180)		
	Radius 28,0 (95)	- (14.3)	- (14.1)		- (13.8)										
32,0 (105)	6,2 (13.8)	6,2 (13.7)	6,1 (13.5)	6,0 (13.3)	5,9 (13.2)	5,8 (12.9)	5,7 (12.7)	5,6 (12.5)	5,5 (12.2)		5,4 (12.0)	5,3 (11.8)			
36,0 (120)	5,9 (13.1)	5,9 (13.0)	5,8 (12.9)	5,7 (12.7)	5,7 (12.6)	5,6 (12.4)	5,5 (12.2)	5,4 (12.0)	5,3 (11.8)		5,2 (11.6)	5,1 (11.4)	5,0 (11.1)		
42,0 (140)	5,5 (12.2)	5,5 (12.2)	5,5 (12.1)	5,4 (11.9)	5,3 (11.8)	5,3 (11.7)	5,2 (11.5)	5,1 (11.4)	5,0 (11.2)		5,0 (11.0)	4,9 (10.8)	4,8 (10.6)		
48,0 (160)	4,9 (10.8)	5,0 (11.0)	5,1 (11.3)	4,9 (10.6)	5,0 (10.9)	5,0 (11.1)	4,8 (10.5)	4,8 (10.7)	4,8 (10.7)		4,7 (10.2)	4,7 (10.3)	4,6 (10.2)		
54,0 (180)	4,4 (9.6)	4,5 (9.8)	4,6 (10.0)	4,3 (9.5)	4,4 (9.7)	4,5 (9.8)	4,2 (9.3)	4,3 (9.5)	4,4 (9.7)		4,2 (9.2)	4,3 (9.3)	4,3 (9.5)		
62,0 (200)	3,8 (8.7)	3,9 (8.8)	4,0 (9.0)	3,8 (8.6)	3,8 (8.7)	3,9 (8.9)	3,7 (8.4)	3,8 (8.6)	3,8 (8.7)		3,7 (8.3)	3,7 (8.4)	3,7 (8.5)		
68,0 (220)	- (8.0)	3,6 (8.1)	3,6 (8.2)	3,5 (7.8)	3,5 (7.9)	3,5 (8.1)	3,4 (7.7)	3,5 (7.8)	3,3 (7.6)		3,3 (7.6)	3,4 (7.7)	3,2 (7.3)		
72,0 (240)							3,2 (6.7)	3,2 (6.9)	2,9 (6.2)		3,1 (6.5)	3,0 (6.6)	2,7 (5.8)		
76,0 (250)											2,5 (5.6)	2,6 (5.9)	2,3 (5.2)		

For complete chart, refer to www.cranelibrary.com.

Meets ANSI B30.5 Requirements - Capacities do not exceed 75% of static tipping load.
 NOTICE: This capacity chart is for reference only and must not be used for lifting purposes.

Fixed jib on luffing jib load charts

Liftcrane fixed jib on luffing jib capacities - Series 2

Fixed jib No. 138 at 3 degree angle on luffing jib No. 139 on boom No. 78

64 410 kg (142,000 lb) Upperworks counterweight 19 960 kg (44,000 lb) Carbody counterweight

360° Rating

kg (lb) x1000

70° boom angle

Luffing jib m (ft)	42,7 (140)			45,7 (150)			48,8 (160)			51,8 (170)		
	42,7 (140)	48,8 (160)	54,9 (180)	42,7 (140)	48,8 (160)	54,9 (180)	42,7 (140)	48,8 (160)	54,9 (180)	42,7 (140)	48,8 (160)	54,9 (180)
Radius												
– (150)	– (13.6)											
48,0 (160)	5,6 (12.2)	5,1 (11.0)	– (9.3)	5,6 (12.1)	– (10.9)		– (11.7)					
50,0 (170)	5,3 (11.1)	4,8 (10.0)	4,0 (8.5)	5,2 (10.9)	4,7 (9.8)	– (8.2)	5,0 (10.6)	– (9.4)		– (10.3)	– (9.1)	
54,0 (180)	4,6 (10.0)	4,2 (9.0)	3,6 (7.8)	4,6 (9.9)	4,1 (8.8)	3,5 (7.5)	4,4 (9.5)	3,9 (8.5)	3,2 (7.0)	4,2 (9.2)	3,8 (8.2)	– (6.7)
56,0 (190)	4,3 (9.1)	3,9 (8.1)	3,4 (7.0)	4,3 (9.0)	3,8 (8.0)	3,2 (6.9)	4,1 (8.6)	3,6 (7.6)	3,0 (6.3)	4,0 (8.3)	3,5 (7.3)	2,9 (6.1)
60,0 (200)	3,8 (8.3)	3,4 (7.3)	2,9 (6.3)	3,8 (8.2)	3,3 (7.2)	2,8 (6.2)	3,6 (7.8)	3,1 (6.8)	2,6 (5.7)	3,5 (7.5)	3,0 (6.5)	2,5 (5.4)
64,0 (210)	3,4 (7.5)	2,9 (6.6)	2,5 (5.7)	3,3 (7.4)	2,9 (6.5)	2,4 (5.5)	3,1 (7.0)	2,7 (6.1)	2,3 (5.1)	3,0 (6.8)	2,6 (5.9)	2,1 (4.8)
68,0 (230)		2,6 (5.4)	2,2 (4.5)	2,9 (6.1)	2,5 (5.3)	2,1 (4.4)	2,7 (5.7)	2,4 (4.9)	2,0 (4.0)	2,6 (5.5)	2,2 (4.7)	1,8 (–)
72,0 (240)					2,2 (4.7)		2,4 (5.1)	2,0 (4.4)		2,3 (4.9)	1,9 (4.1)	
76,0 (250)										2,0 (4.4)		

Luffing jib m (ft)	42,7 (140)			45,7 (150)			48,8 (160)			51,8 (170)		
	42,7 (140)	48,8 (160)	54,9 (180)	42,7 (140)	48,8 (160)	54,9 (180)	42,7 (140)	48,8 (160)	54,9 (180)	42,7 (140)	48,8 (160)	54,9 (180)
Radius												
50,0 (165)	– (11.8)											
52,0 (175)	5,0 (10.7)	4,5 (9.6)		5,0 (10.5)	– (9.4)		– (10.2)					
56,0 (190)	4,4 (9.3)	3,9 (8.3)	3,3 (6.9)	4,4 (9.2)	3,9 (8.1)	– (6.6)	4,2 (8.8)	– (7.7)	– (6.1)	4,0 (8.5)	– (7.4)	
60,0 (200)	3,9 (8.5)	3,5 (7.5)	2,9 (6.3)	3,8 (8.3)	3,4 (7.4)	2,8 (6.1)	3,7 (8.0)	3,2 (7.0)	2,5 (5.6)	3,6 (7.7)	3,1 (6.7)	2,4 (5.3)
62,0 (210)	3,7 (7.8)	3,3 (6.8)	2,7 (5.8)	3,6 (7.6)	3,2 (6.7)	2,6 (5.5)	3,5 (7.2)	3,0 (6.3)	2,4 (5.1)	3,3 (7.0)	2,9 (6.0)	2,3 (4.8)
64,0 (230)	3,5 (6.5)	3,0 (5.6)	2,6 (4.7)	3,4 (6.3)	3,0 (5.5)	2,4 (4.5)	3,2 (6.0)	2,8 (5.1)	2,3 (4.1)	3,1 (5.7)	2,7 (4.8)	2,1 (–)
68,0 (240)	3,1 (5.9)	2,7 (5.1)	2,2 (4.2)	3,0 (5.8)	2,6 (5.0)	2,2 (4.0)	2,9 (5.4)	2,5 (4.6)	1,9 (–)	2,7 (5.1)	2,3 (4.3)	1,8 (–)
72,0 (250)	2,7 (5.4)	2,4 (4.6)	2,0 (–)	2,6 (5.2)	2,3 (4.5)	1,9 (–)	2,5 (4.9)	2,1 (4.1)		2,4 (4.6)	2,0 (–)	
76,0 (260)	2,4 (–)	2,1 (4.1)		2,3 (4.7)	2,0 (4.0)		2,2 (4.4)	1,8 (–)		2,1 (4.2)		
80,0 (270)							1,9 (4.0)					

For complete chart, refer to www.cranelibrary.com.

Meets ANSI B30.5 Requirements - Capacities do not exceed 75% of static tipping load.
 NOTICE: This capacity chart is for reference only and must not be used for lifting purposes.

Manitowoc Crane Care

Crane Care is Manitowoc's comprehensive service and support program. It includes classroom and on-site training, prompt parts availability, expert field service, technical support and documentation.

That's commitment you won't find anywhere else.

That's Crane Care.

Service training

Manitowoc specialists work with you in our training centers and in the field to make sure you know how to get maximum performance, reliability and life from your cranes.

Manitowoc Cranes Technical Training Centers provide valuable multi-level training, which is available for all models and attachments, in the following format:

- **Intro to Canbus and Canbus 1, 2, 3**
- **Intro to EPIC and EPIC 1, 2, 3**
- **Small Crawler 1**
- **Canbus 1 and 2 assembly, operation and maintenance**
- **EPIC 1 and 2 assembly, operation and maintenance**

Refer to www.manitowoc.com for course descriptions.

Parts availability

Genuine Manitowoc replacement parts are accessible through your distributor 24 hours a day, 7 days a week, 365 days a year.

Service interval kits

200 hour kit

1,000 hour kit

2,000 hour kit

Hydraulic test kit

U.S. standard tools kit

Field service

Factory-trained service experts are always ready to help maintain your crane's peak performance.

For a worldwide listing of dealer locations, please consult our website at: www.manitowoc.com

Technical support

Manitowoc's dealer network and factory personnel are available 24 hours a day, 7 days a week, 365 days a year to answer your technical questions and more, with the help of computerized programs that simplify crane selection, lift planning, and ground-bearing calculations.

For a worldwide listing of dealer locations, please consult our website at: www.manitowoc.com

Technical documentation

Manitowoc has the industry's most extensive documentation; available in major languages and formats that include print, videotape, and DVD/CD.

Additional copies available through your Authorized Manitowoc Distributor.

- Crane operator's manual
- Crane parts manual
- Crane capacity manual
- Crane vendor manual
- Crane service manual
- Luffing jib operator's/parts manual
- Capacity chart manual - attachments

CD rom versions of the operator's and parts manuals are shipped with each crane. Also available are the following CDs:

- Crane Care Owner CD –
- Ground Bearing Pressure Estimator CD
- Crane Selection and Planning Software (CompuCRANE®)
- EPIC® Crane Library CD consisting of capacity charts, range diagrams, wire rope specifications, travel specifications, crane weights, counterweight arrangements, luffing jib raising procedures, operating range diagrams, drum and lagging charts, boom rigging drawings, jib rigging drawings, outline dimensions and wind condition charts.

Available from your Authorized Manitowoc Cranes Distributor, these videos are available in NTSC, PAL, SECAM, and DVD formats.

- Your Capacity Chart Video
- Respect the Limits Video
- Crane Safety Video
- Boom Inspection/Repair Video

Crane Care Package

Manitowoc has assembled all of the available literature, CD's and videos listed above plus several Manitowoc premiums into one complete Crane Care Package.

Notes

Notes

Regional headquarters

Manitowoc - Americas

Manitowoc, Wisconsin, USA

Tel: +1 920 684 6621

Fax: +1 920 683 6277

Shady Grove, Pennsylvania, USA

Tel: +1 717 597 8121

Fax: +1 717 597 4062

Manitowoc - Europe, Middle East, Africa

Ecully, France

Tel: +33 (0)4 72 18 20 20

Fax: +33 (0)4 72 18 20 00

Manitowoc - Asia Pacific

Shanghai, China

Tel: +86 21 6457 0066

Fax: +86 21 6457 4955

Regional offices

Americas

Brazil

Alphaville

Mexico

Monterrey

Chile

Santiago

Portugal

Baltar

Russia

Moscow

U.A.E.

Dubai

U.K.

Buckingham

Factories

Brazil

Alphaville

China

TaiAn

Zhangjiagang

France

Charlieu

La Clayette

Moulines

Germany

Wilhelmshaven

India

Pune

Italy

Niella Tanaro

Portugal

Baltar

Fânzeres

Slovakia

Saris

USA

Manitowoc

Port Washington

Shady Grove

This document is non-contractual. Constant improvement and engineering progress make it necessary that we reserve the right to make specification, equipment, and price changes without notice. Illustrations shown may include optional equipment and accessories and may not include all standard equipment.